

CTD SERIES

寶獅牌工業用縫紉機 INDUSTRIAL SEWING MACHINE

MODEL
CTD9000

&

UTB03

UTC03

UTG03

UTH03

STB03

STC03

WPC02

WPG01



**DIRECT DRIVE CYLINDER BED
COVERSTITCH INTERLOCK
STITCH MACHINE AND
DEVICES / ATTACHMENTS**

Parts List



精機機械廠股份有限公司 CHING CHI MACHINE CO., LTD
<http://www.kingtexsewing.com.tw>

Ver 3.6 2022.05
NO.CT6300-1M-06-01

CTD9000 CONTENTS

序號 Ref. No.	名 稱 Description	頁 次 Page No.
1	CTD9000 本體與外裝零件 Frame Components For CTD9000 (一) -----	1
2	CTD9000 本體與外裝零件 Frame Components For CTD9000 (二) -----	3
3	CTD9000 導線與張力調整零件 Thread Guide And Tension Components For CTD9000 -----	5
4	CTD9000 軸襯與油封 Bushing And Seal For CTD9000 -----	7
5	CTD9000/CTU9011 下軸與相關零件 Lower Main Shaft Components -----	9
6	CTD9000/CTD9711/CXD2711 上軸與相關零件 Upper Main Shaft Components -----	11
7	CT9000 / CX2000 / CTD9000 / CXD2000 / CXM2000 針棒與相關零件 Needle Bar Components -----	13
8	CX2000 / CTD9000 / CTD9711 / CXD2000 / CXM2000 / CXD2711 壓腳與相關零件 Presser Foot Components -----	15
9	CT9000 / CT9711 / CX2000 / CTD9000 / CTD9711 / CXD2000 / CXM2000 CXD2711裝飾線驅動機構 Spreader Mechanism -----	17
10	CT9000 / CTD9000 / CTU9011 結線鉤驅動機構 Looper Driving Mechanism -----	19
11	CT9000 / CTD9000 / CTU9011 進給變換機構 Feed Control Driving -----	21
12	CT9000 / CTD9000 / CTU9011 導針與送布齒驅動機構 Needle Guide And Feed Dog Driving For CT9000 / CTD9000 / CTU9011 ----	23
13	CTD9000 潤滑系統 Lubrication System For CTD9000 -----	25
14	66707 線架 Thread Stand 66707 -----	29
15	CTD9000 / CTU9011 / CXD2000 / CXM2000 / CXN2000 / CXU2000 裝載附件 Supporting Board -----	31
16	CTD9000 / CXD2000 / CXM2000 工具及附件 Accesseries -----	33
17	車型定規列表 Gauge Parts List -----	35

1. CTD9000 本體與外裝零件 Frame Components For CTD9000 (一)

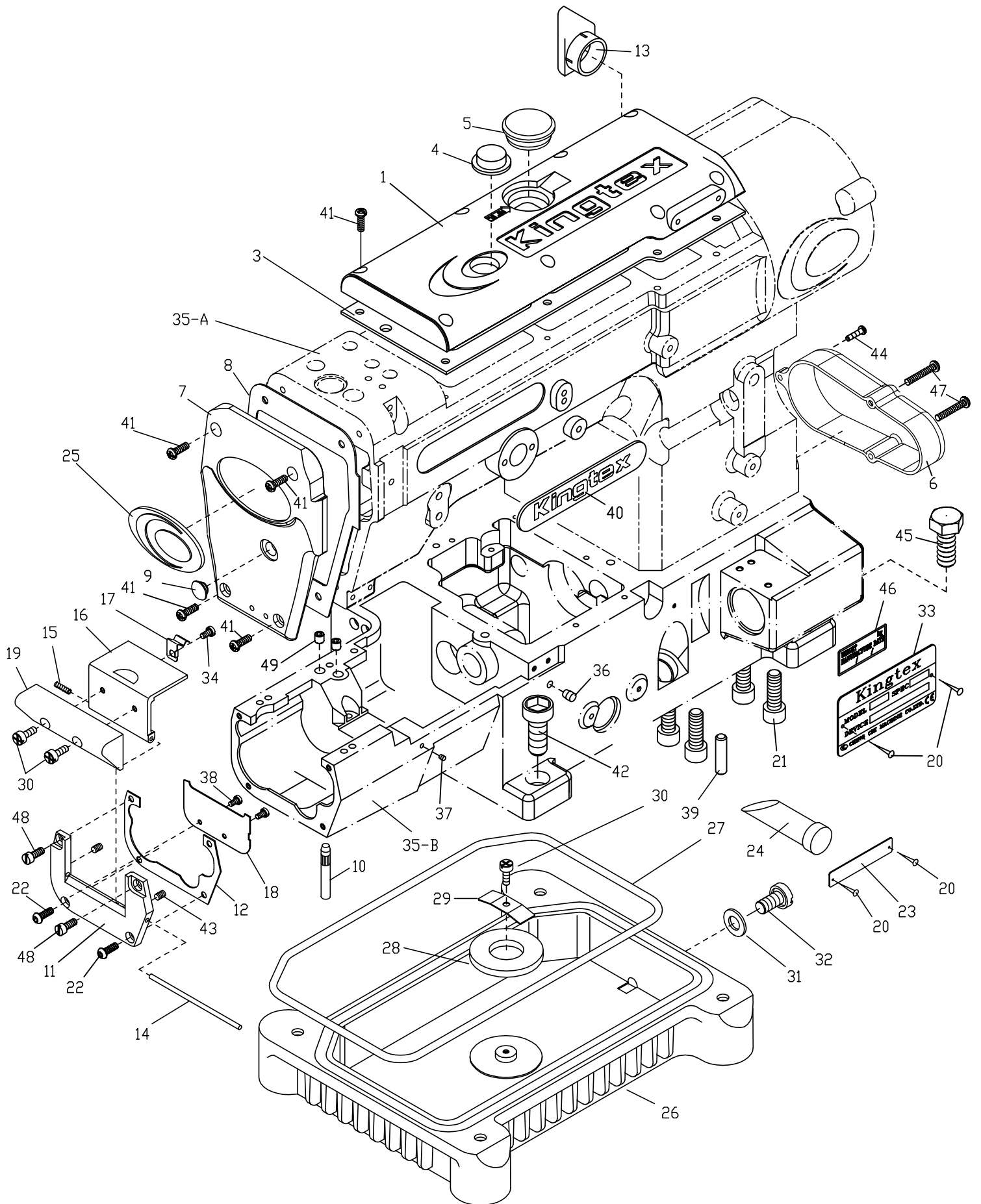

1. CTD9000 本體與外裝零件 Frame Components For CTD9000 (一)

序號 Ref.No.	物料編號 Parts No.	名稱 Description	單位用量 Amt .Req.
1	22400001011	上軸蓋 Top Cover -----	1
2	-----	-----	-
3	22400001032	油封 Gasket -----	1
4	22400001041	油鏡 Oil Window -----	1
5	22200002552	孔塞 Plug -----	1
6	2240000106	側蓋 Side Cover -----	1
7	22400001071	針棒蓋 Needle Cover -----	1
8	22400001081	油封 Gasket -----	1
9	22000001091	孔塞 Plug -----	1
10	2200000110	下座腳樁 Supporting Bar -----	4
11	2220000111	固定座 Bucket -----	1
12	2220000112	油封 Gasket -----	1
13	22400001131	導風管 Guid Pipe-----	1
14	22200001141	樞銷 Hinge Pin -----	1
15	2220000115	彈簧 Spring -----	1
16	2220000116	下軸側蓋 Side Cover -----	1
17	2220000117	夾簧 Latch Spring -----	1
18	22200001182	檔片 Defender -----	1
19	2220000119	下軸側蓋 Side Cover -----	1
20	66620	鉚釘 Rivet -----	4
21	8MM10603016A	螺絲 Serew (CT0138 M10-1.5*30) -----	4
22	8MP85241006A	螺絲 Serew (M3.5-0.6*10) -----	2
23	66480-14	機器號碼牌 Machine No. Plate -----	1
24	2220000124	油面鏡 Oil Sign Gauge-----	1
25	66484-11	銘板 Plate -----	1
26	2220000126	油盤 Oil Reservoir -----	1
27	2200000127	油封 Gasket -----	1
28	2200000128	磁鐵 Magnet -----	1
29	2200000129	壓板 Holder -----	1
30	8MC04280807D	螺絲 Screw (CT0130 M4-0.7*8) -----	3
31	2100000244	油封 Seal -----	1
32	8SM95281017A	螺樁 Stud (SH0243 3/8"-28*10) -----	1
33	66485-1	車型銘板 Model Plate -----	1
34	8MK04280507A	螺絲 Screw (WPC0106 M4-0.7*5) -----	1
35	2240000135	車頭 Frame Unit -----	1
35-A	2240000135A	上車頭 Upper Frame Unit -----	1
35-B	2270000135B	下車頭 Lower Frame Unit -----	1
36	2200000136	孔塞 Plug -----	1
37	2200000137	孔塞 Plug -----	1
38	8MB03200405A	螺絲 Screw (FT0548 M3-0.5*4) -----	2
39	2200000139	定位銷 Knock Pin -----	2
40	66485-9	上車頭銘板 Plate -----	1
41	8MC04281207D	螺絲 Screw (CT0102 M4-0.7*12) -----	12
42	8MM08502013A	螺絲 Screw (CT0106 M8-1.25*20) -----	3
43	8MN03200300A	螺絲 Screw (CT0115 M3-0.5*3) -----	2
44	8MC04281607D	螺絲 Screw (UH0177 M4-0.7*16) -----	1
45	8MK08502013A	螺絲 Screw (C90140 M8-1.25*20) -----	1
46	66477-4	重量貼紙 Weight Paster -----	1
47	8MC04283307D	螺絲 Screw (C80147 M4-0.7*33) -----	2
48	8MB85241006K	螺絲 Screw (CT0621 M3.5-0.6*10) -----	2
49	8MN06400600A	螺絲 Screw (CT0918 M6-1*6) -----	2

2. CTD9000 本體與外裝零件 Frame Components For CTD9000 (二)

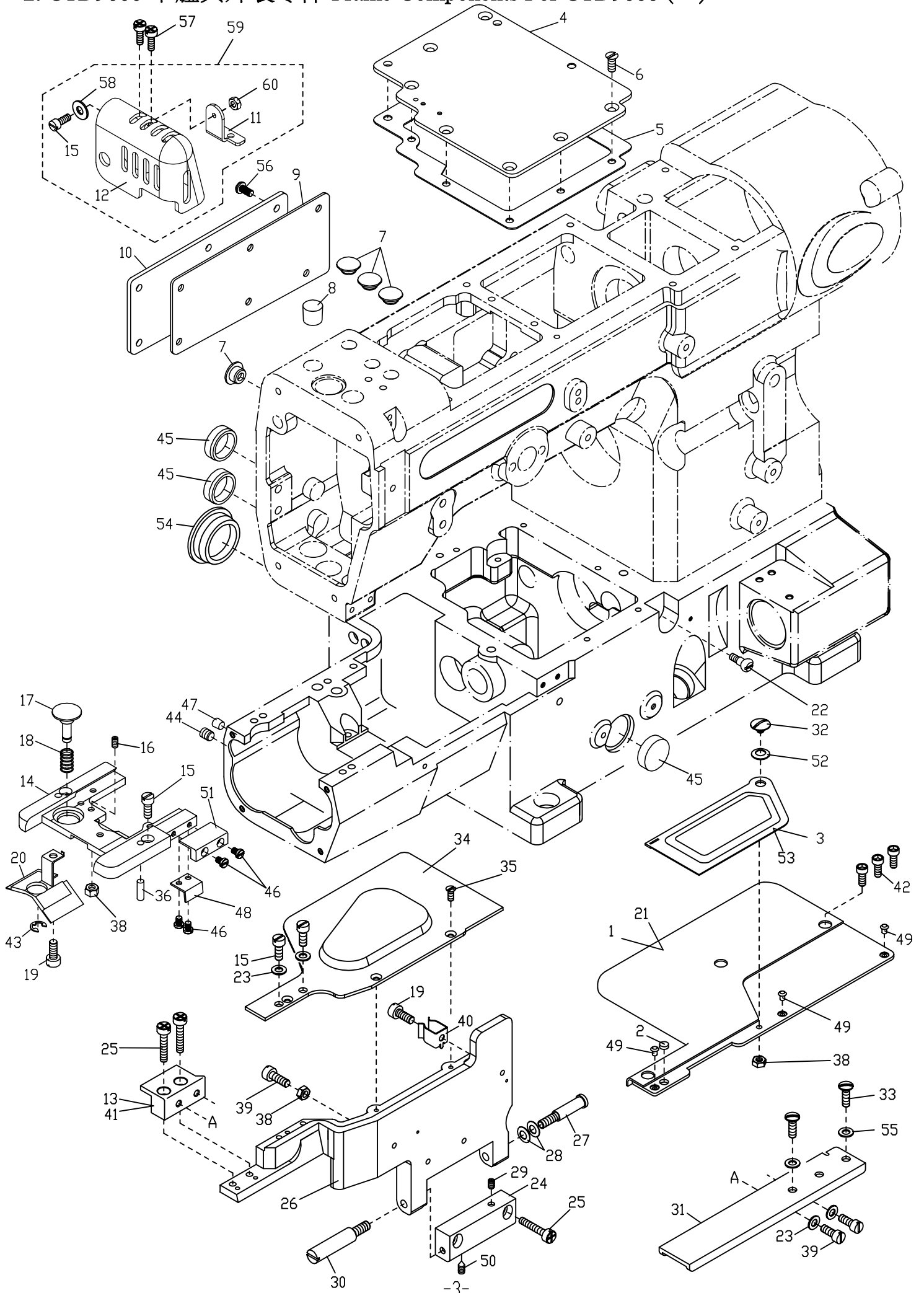

2. CTD9000 本體與外裝零件 Frame Components For CTD9000 (二)

序號 Ref.No	物料編號 Parts No.	名稱 Description	單位用量 Amt.Req.
*1	2270000201	下軸外蓋 Cloth Plate -----	1
2	2270000202	磁鐵 Magnet -----	1
*3	2270000203	防塵蓋 Dust Cover -----	1
4	2270000204	下軸內蓋 Lower Shaft Cover -----	1
5	2220000205	防油墊片 Gasket -----	1
6	8ME04280708A	螺絲 Screw (CT0206 M4-0.7*7) -----	7
7	22000001091	孔塞 Plug -----	4
8	22000002081	孔塞 Plug -----	1
9	22000002091	油封 Gasket -----	1
10	2200000210	上軸背蓋 Rear Cover -----	1
11	2270000211	基座 Base -----	1
12	22700002121	針棒護蓋 Needle Bar Protector -----	1
*13	2270000213	下座前蓋活動塊 Movable Block -----	1
14	2220000214	針板座 Needle Plate Seat -----	1
15	8MB04280807K	螺絲 Screw (CT0215 M4-0.7*8) -----	5
16	8MN04281000A	螺絲 Screw (CT0216 M4-0.7*10) -----	1
17	2220000217	按鈕 Push Button -----	1
18	2200000218	彈簧 Spring -----	1
19	8MC04280507D	螺絲 Screw (CT0122 M4-0.7*5) -----	2
20	2220000220	油封 Oil Defender -----	1
**21	2270000221	下軸外蓋 Cloth Plate -----	1
22	8MD04281408C	螺樁 Stud (CT0222 M4-0.7*5) -----	1
23	2100000223	墊圈 Washer -----	4
24	2200000224	絞鏈 Hinge -----	1
25	8MC04281407D	螺絲 Screw (CT0225 M4-0.7*14) -----	4
26	2270000226	下座前蓋 Front Cover -----	1
27	8MB04283809E	螺樁 Stud (CT0227 M4-0.7*38) -----	1
28	2200000228	盂形墊圈 Disk Washer -----	2
29	8MN04280400A	螺絲 Screw (CT0229 M4-0.7*4) -----	1
30	8MB04280605M	螺樁 Stud (CT0230 M4-0.7*6) -----	1
31	2200000231	輔助緣板 Auxiliary Cloth Plate -----	1
32	8MC04280512B	螺絲 Screw (C90232 M4-0.7*5) -----	1
33	8MB05321008K	螺絲 Screw (CT0233 M5-0.8*10) -----	2
34	2270000234	護線蓋 Cloth Plate -----	1
35	8ME03200606A	螺絲 Screw (CT0235 M3-0.5*6) -----	3
36	90ST0410	定位銷 Knock Pin -----	2
37	-----	-----	-
38	8MA04280307A	螺帽 Nut (CT0238 M4-0.7*3) -----	3
39	8MB04281207K	螺絲 Screw (CT0239 M4-0.7*12) -----	3
40	2200000121	夾簧 Latch Spring -----	1
**41	2270000241	下座前蓋活動塊 Movable Block -----	1
42	8MM04281207A	螺絲 Screw (CT0202 M4-0.7*12) -----	3
43	90ER040	E形扣環 E-Ring -----	1
44	8MN06400600A	螺絲 Screw (CT0244 M6-1*6) -----	2
45	22000002451	孔塞 Plug -----	3
46	8MB03200405A	螺絲 Screw (FT0548 M3-0.5*4) -----	4
47	22000002471	孔塞 Plug -----	2
48	2200000250	擋片 Defender -----	1
49	22100001191	減震橡膠 Rubber Cushion -----	3
50	8MN04280500C	螺絲 Screw (FT1222 M4-0.7*5) -----	1
51	2220000257	擋片 Defender -----	1
52	2200000124	盂形墊圈 Disc Washer -----	1
**53	2270000253	防塵蓋 Dust Cover -----	1
54	22000002461	孔塞 Plug -----	1
55	2200001025	墊圈 Washer -----	2
56	8MC04281007D	螺絲 Screw (CT0113 M4-0.7*10) -----	6
57	8MC04280807D	螺絲 Screw (CT0130 M4-0.7*8) -----	2
58	90DW040	墊圈 Washer -----	1
59	227A0000259	針棒護蓋組 Needle Bar Protector Asm. -----	1
60	8MA04280207A	螺帽 Nut (STC02-01-02 M4-0.7*2.5) -----	1

* : 40M,48M,56M用 For 40M, 48M,56M

** : 64M用 For 64M

3. CTD9000 導線與張力調整零件 Thread Guide Tension Components For CTD9000

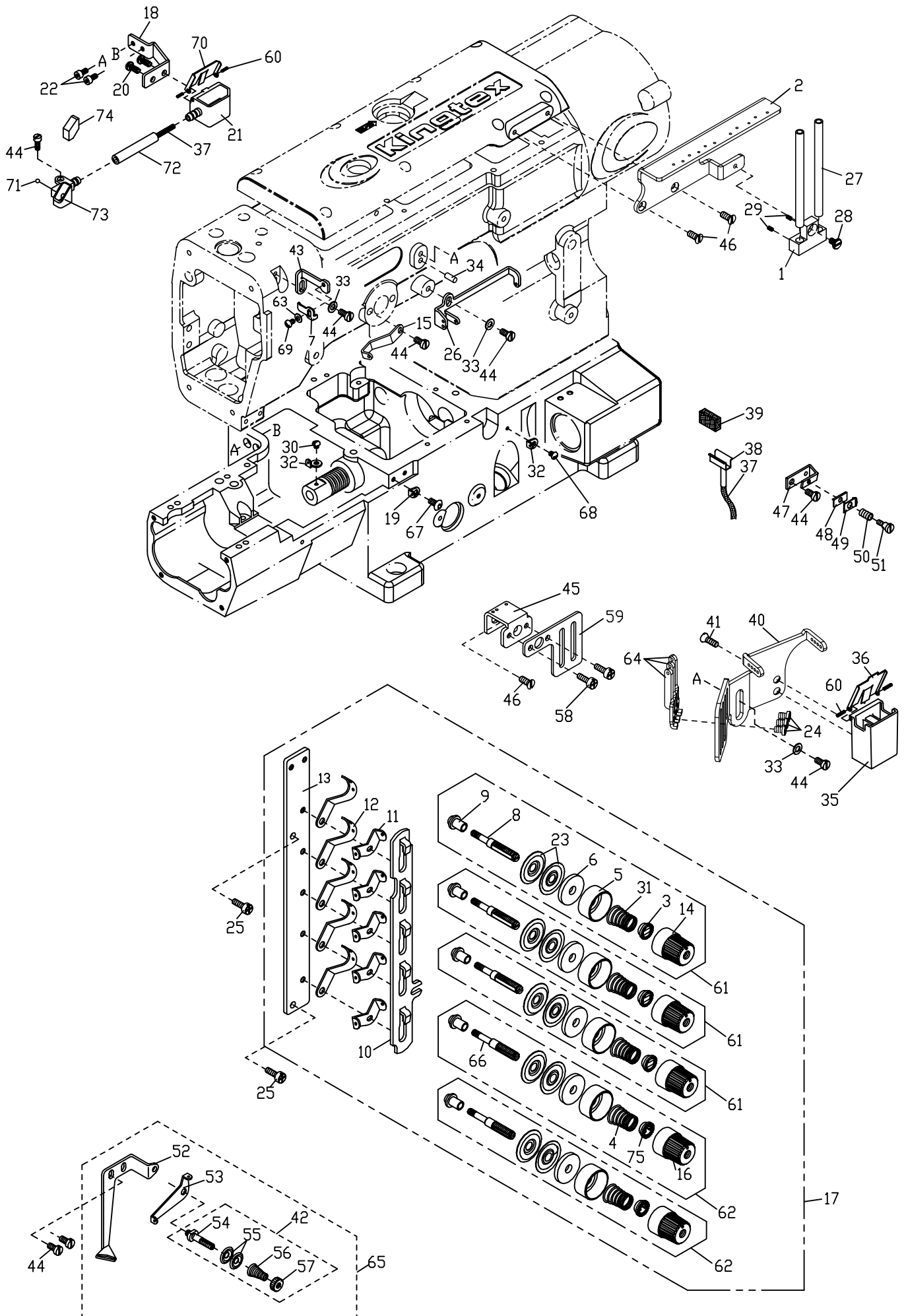

3. CTD9000 導線與張力調整零件 Thread Guide And Tension Components For CTD9000

序號 Ref.No.	物料編號 Parts No.	名稱 Description	單位用量 Amt. Req.
1	2240000301	導線座 Thread Guide Holder -----	1
2	22400003021	導線座 Thread Guide Holder -----	1
3	2200000303	套管 Bushing -----	3
4	2100041131	彈簧 Spring (Yellow) (SH1131)-----	2
5	2200000305	彈簧座 Spring Seat -----	5
6	2100001127	羊毛氈 Felt -----	5
7	2600000307	導線 Thread Guide -----	1
8	22000003081	螺樁 Stud -----	3
9	22000003091	隔環 Spacer -----	5
10	4UTB0004191	鬆線滑板 Release Wedge -----	1
11	2200000311	導線 Thread Guide -----	5
12	2200000312	導線 Thread Guide -----	5
13	4UTB000420	張力控制組座 Tension Post Support -----	1
14	2100001121	張力調整螺帽 Tension Nut (Red) (SH1121)-----	3
15	2210000317	導線 Thread Guide -----	1
16	2100001121A	張力調整螺帽 Tension Nut (Yellow) (SH1121)-----	2
17	224A00003171	鬆線組 Therad Tension Mechanism -----	1
18	2270000318	支架 Knife Holder Bracket -----	1
19	2270000319	導線 Thread Guide -----	1
20	8TC85520806A	螺絲 Screw -----	2
21	22000007261	冷卻油槽 Cooler Oil Tank -----	1
22	8MM04280807A	螺絲 Screw (MT0124 M4-0.7*8) -----	2
23	2100001126	張力控制盤 Tension Disc -----	10
24	8MB03200405A	螺絲 Screw (FT0548 M3-0.5*4) -----	3
25	8MC04280807D	螺絲 Screw (CT0130 M4-0.7*8) -----	2
26	2210000326	導線 Thread Guide -----	1
27	2200000327	導線管 Thread Guide Pipe -----	2
28	8MB04280608A	螺絲 Screw (UTB0130 M4-0.7*6) -----	1
29	8MN03200300A	螺絲 Screw (CT0115 M3-0.5*3) -----	2
30	8MD03200306A	螺絲 Screw (CT0242 M3-0.5*3) -----	1
31	2100001123	彈簧 Spring (Red) (SH1123)-----	3
32	2200001008	導線 Thread Guide -----	2
33	2100000223	墊圈 Washer -----	3
34	90ST0410	定位銷 Knock Pin -----	1
35	22000003351	油杯 Cooler Oil Tank -----	1
36	2200000336	油杯蓋 Cooler Oil Tank Cover -----	1
37	66800	油線 Oil Wick -----	2
38	2200000338	線夾 Wick Clamp -----	1
39	2200000339	羊毛氈 Felt -----	1
40	2270000340	導線 Thread Guide -----	1
41	8TE03440806A	螺絲 Screw -----	2
42	227A0000342	張力控制組 Thread Retainer Asm -----	1
43	2600000343	導線 Thread Guide -----	1
44	8MB04280807K	螺絲 Screw (CT0215 M4-0.7*8) -----	8
45	2200000345	導線 Thread Guide -----	1
46	8ME04280708A	螺絲 Screw (CT0206 M4-0.7*7) -----	3
47	2200000347	張力控制組座 Thread Retainer Support -----	1
48	2200000348	針線控制板 Thread Guide Plate -----	1
49	2200000349	針線控制壓板 Tension Control plate -----	1
50	22000003501	彈簧 Spring -----	1
51	8MC03200807G	螺樁 Stud (CT0351 M3-0.5*8) -----	1
52	2200000352	導線 Thread Guide -----	1
53	2200000353	導線 Thread Guide -----	1
54	2200000354	螺樁 Stud -----	1
55	2200000355	張力控制盤 Tension Disc -----	2
56	2200000356	彈簧 Spring -----	1
57	2200000357	螺帽 Nut -----	1
58	8MC04280507D	螺絲 Screw (CT0122 M4-0.7*5) -----	2
59	2200000359	揚線臂護線罩 Take-up Arm Protect -----	1
60	90SP0206T	彈簧銷 Spring Pin -----	4
61	231A0001922	張力控制組 Thread Asm. (Red) -----	3
62	220A0000315	張力控制組 Thread Asm. (Yellow) -----	2
63	90DW030	碟形墊圈 Disk Washer -----	1
64	2270000364	導線桿 Thread Guide -----	3
65	220A0000365	鬆線組 Therad Tension Mechanism -----	1
66	22000003611	螺樁 Stud -----	2
67	8MP04280808A	螺絲 Screw (MT0235 M4-0.7*8) -----	1
68	8MD03200606A	螺絲 Screw (CT0326 M3-0.5*6) -----	1
69	8MB03200506K	螺絲 Screw (CT0525 M3-0.5*5) -----	1
70	2200000725	冷卻油槽蓋 Cooler Oil Tank Cover -----	1
71	2100000403	孔塞 Plug -----	1
72	66792	油管 Oil Tube ($\varnothing 4.6 * \varnothing 6.3 * 42 L$)-----	1
73	22000007311	羊毛氈承座 Felt Seat -----	1
74	2200000732	羊毛氈 Felt -----	1
75	2100001122	止滑齒輪 Bush -----	2

4. CTD9000 軸襯與油封 Bushing And Seal For CTD9000

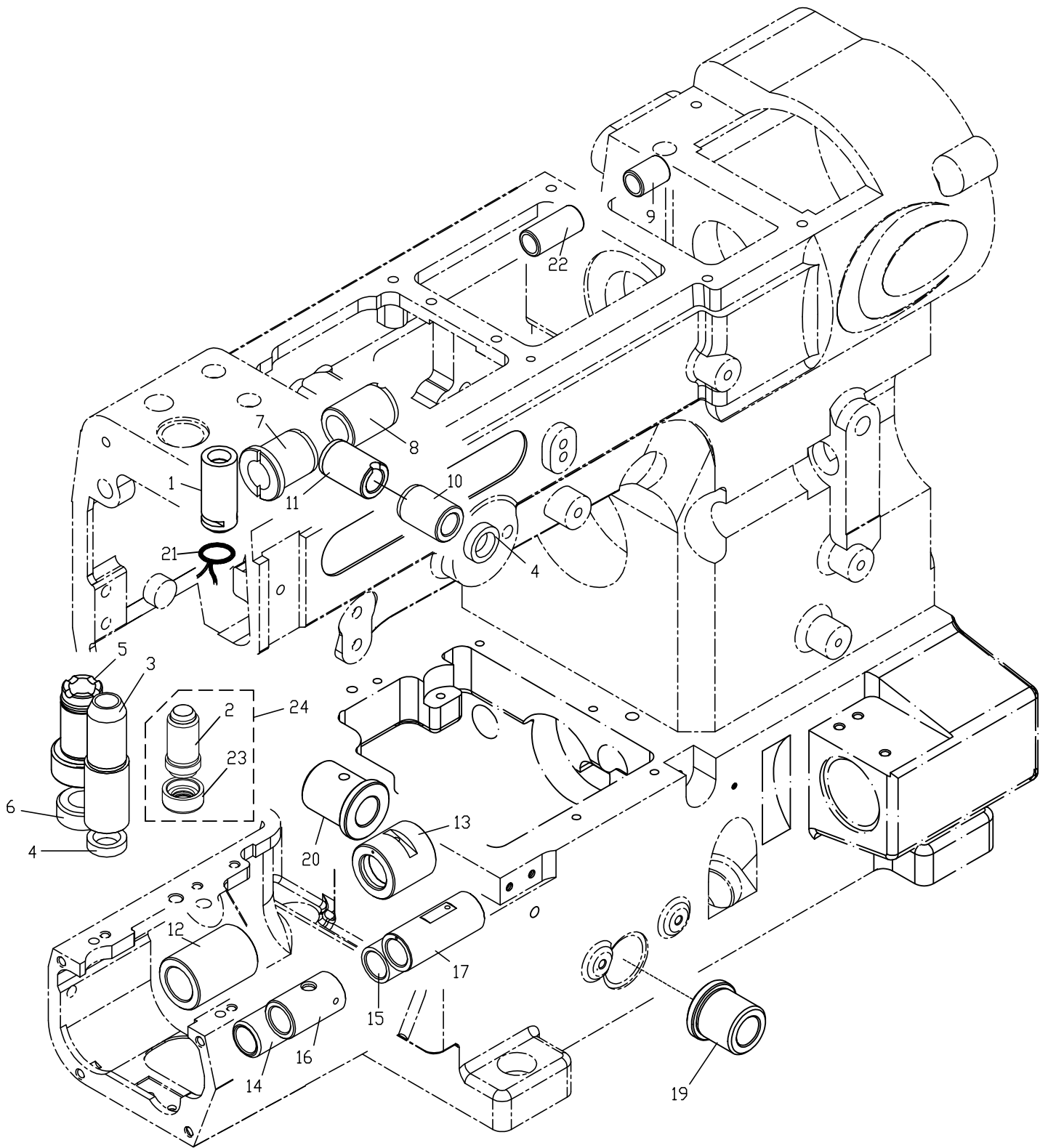

4. CTD9000 軸襯與油封 Bushing And Seal For CTD9000

序號 Ref.No.	物料編號 Parts No.	名稱 Description	單位用量 Amt. Req.
1	2210000401	軸襯 Bushing -----	1
2	22000004021	軸襯 Bushing -----	1
3	2200000403	軸襯 Bushing -----	1
4	2200000404	油封 Oil Seal -----	2
5	22200004051	軸襯 Bushing -----	1
6	2200000406	油封 Oil Seal -----	1
7	2210000408	軸襯 Bushing -----	1
8	2200000408	軸襯 Bushing -----	1
9	2240000409	軸襯 Bushing -----	1
10	22000004101	軸襯 Bushing -----	1
11	2200000411	軸襯 Bushing -----	1
12	22000004121	軸襯 Bushing -----	1
13	2200000413	軸襯 Bushing -----	1
14	2200000414	軸襯 Bushing -----	1
15	2200000415	軸襯 Bushing -----	1
16	2200000416	軸襯 Bushing -----	1
17	2200000417	軸襯 Bushing -----	1
18	-----	-----	-
19	22000004191	軸襯 Bushing -----	1
20	22000004201	軸襯 Bushing -----	1
21	66800	油線 Oil Wick -----	1
22	2240000422	軸襯 Bushing -----	1
23	2270001017	橡膠環 Rubber Washer -----	1
24	227A0000423	軸襯組 Bushing Asm. -----	1

5. CTD9000 / CTU9011 下軸與相關零件 Lower Main Shaft Components

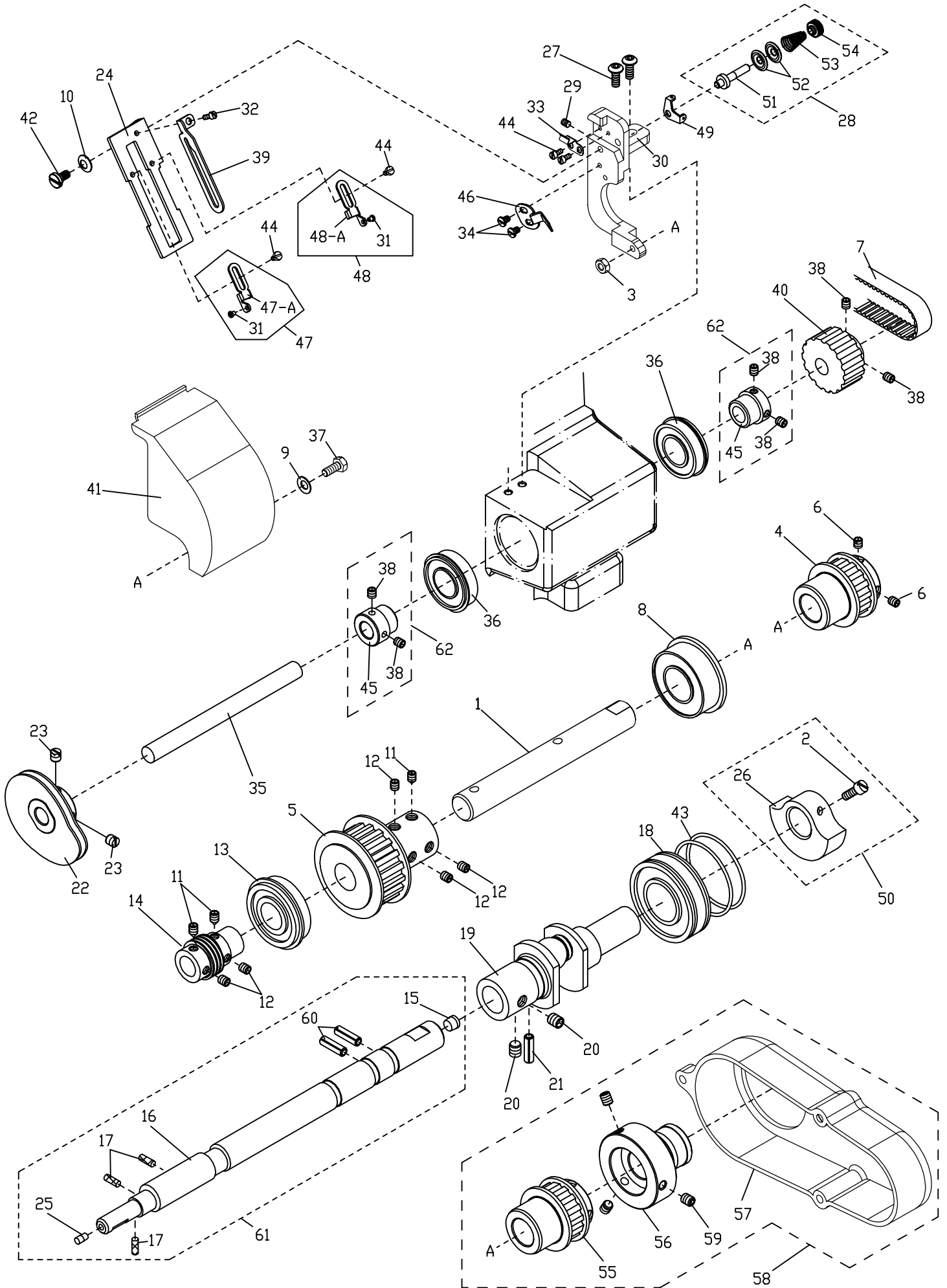

5. CTD9000 / CTU9011下軸與相關零件 Lower Main Shaft Components

序號 Ref.No.	物料編號 Parts No.	名稱 Description	單位用量 Amt.Req.
1	22400005011	軸 Shaft -----	1
2	8MB04280807K	螺絲 Screw (CT0215 M4-0.7*8) -----	2
3	8MA04280307A	螺帽 Nut (CT0238 M4-0.7*3) -----	1
4	2220000504	齒形皮帶輪 Timeing Pulley -----	1
5	2240000505	齒形皮帶輪 Timeing Pulley -----	1
6	8MN05320500E	螺絲 Screw (CT0903 M5-0.8*5) -----	2
7	90TB2853GT	齒形皮帶 Timeing Belt -----	1
8	90BB2552154	滾珠軸承 Ball Bearing -----	1
9	90DW040	碟形墊圈 Disk Washer -----	1
10	2200000228	碟形墊圈 Disk Washer -----	1
11	8MN06400800C	螺絲 Screw (FT0502 M6-1*8) -----	3
12	8MN06400600A	螺絲 Screw (CT0244 M6-1*6) -----	5
13	90BB2047144	滾珠軸承 Ball Bearing -----	1
14	2200000508	蝸桿 Worm -----	1
15	2200000515	孔塞 Plug -----	1
16	2200000516	軸 Shaft -----	1
17	66801	油線 Oil Wick -----	3
18	90BB2042122	滾珠軸承 Ball Bearing -----	1
19	2200000512	曲軸 Crank Shaft -----	1
20	8MN06400500A	螺絲 Screw (CT0513 M6-1*5) -----	2
21	90SP0206	彈簧銷 Pin -----	1
22	2270000522	揚線凸輪 Looper Thread Takeup Cam -----	1
23	8MH05320400A	螺絲 Screw (CT0523 M5-0.8*4) -----	2
24	2270000524	導線固定板 Thread Guide Seat -----	1
25	2200000550	孔塞 Plug -----	1
26	2200000509	平衡錘 Balance Weight -----	1
27	8MP04281008A	螺絲 Screw (MT0250 M4-0.7*10) -----	2
28	227A0000342	張力控制組 Thread Retainer Asm -----	1
29	8MN03200500A	螺絲 Screw (STB-01-16 M3-0.5*5) -----	1
30	22700005301	固定座 Bracket -----	1
31	2600000371	磁導線環 Thread Eyelet -----	2
32	8MB03200306A	螺絲 Screw (FT0208 M3-0.5*3) -----	1
33	22700005331	夾簧 Latch Spring -----	1
34	8MB03200405A	螺絲 Screw (FT0548 M3-0.5*4) -----	2
35	2270000535	軸 Shaft -----	1
36	90BB152807	滾珠軸承 Ball Bearing -----	2
37	8MK04281007A	螺絲 Screw (FT0217 M4-0.7*10) -----	1
38	8MN04280400A	螺絲 Screw (CT0229 M4-0.7*4) -----	6
39	2270000539	導線 Thread Guide -----	1
40	2220000540	齒形皮帶輪 Timeing Pulley -----	1
41	22700005411	凸輪護蓋 Cam Cover -----	1
42	8MB04281008G	螺絲 Screw (C90549 M4-0.7*10) -----	1
43	2200000547	O形油環 O Ring -----	2
44	8MB75180405A	螺絲 Screw (CT0529 M2.5-0.45*3.5) -----	4
45	2270000545	套管接頭 Joint -----	2
46	2220000550	夾簧 Latch Spring -----	1
47	26000005511	導線組 Thread Guide Asm. -----	1
47-A	26000005511A	導線 Thread Guide -----	1
48	26000005521	導線組 Thread Guide Asm. -----	1
48-A	26000005521A	導線 Thread Guide -----	1
49	2270000317	導線 Thread Guide -----	1
50	222A0000647	平衡錘組 Balance Weight Asm -----	1
51	2200000354	螺椿 Stud -----	1
52	2200000355	張力控制盤 Tension Disc -----	2
53	2200000356	彈簧 Spring -----	1
54	2200000357	螺帽 Nut -----	1
*55	2240000555	齒形皮帶輪 Timeing Pulley -----	1
*56	2240000556	套管 Joint -----	1
*57	2240000557	側蓋 Side Cover -----	1
*58	224A0000558	套管接頭組 Joint Asm -----	1
*59	8MN05320600A	螺絲 Screw (MT0729 M5-0.8*6) -----	3
60	90SP0206T	彈簧銷 Pin -----	2
61	220A0000553	下軸組 Lower Shaft Set. -----	1
62	227A0000552	套管接頭組 Joint Asm -----	2

* 特註品 Custom-made Item (搭配數針器使用)

6. CTD9000 / CTD9711 / CXD2711 上軸與相關零件 Upper Main Shaft Components

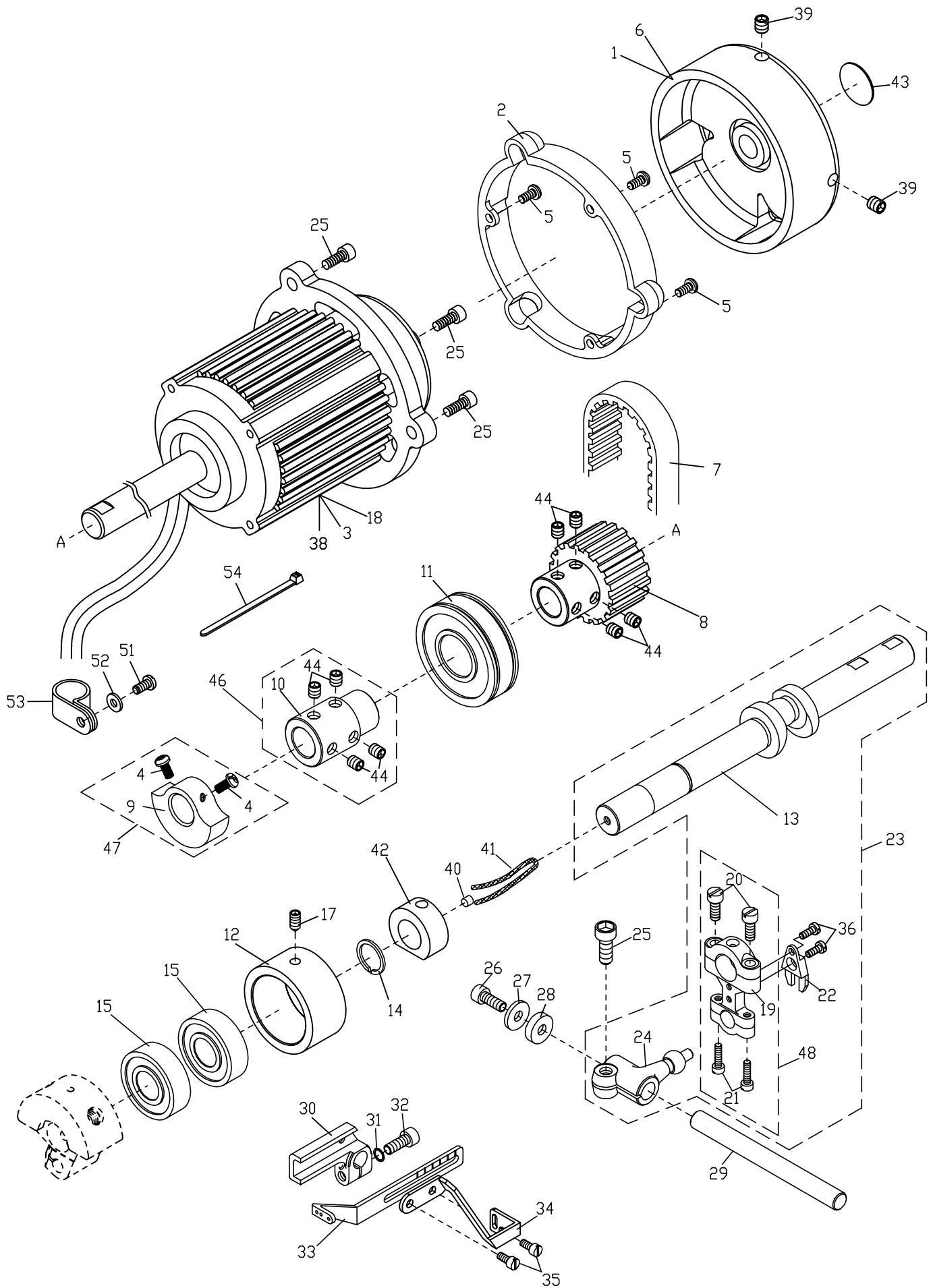

6. CTD9000/CTD9711/CXD2711 上軸與相關零件 Upper Main Shaft Components

序號 Ref.No.	物料編號 Parts No.	名稱 Description	單位用量 Amt. Req.
1	2240000601	手輪 Handwheel -----	1
2	2240000602	護蓋 Cover -----	1
3	22400006032	迷你馬達 Mini Motor -----	1
4	8MB04280807K	螺絲 Screw(CT0215 M4-0.7*8) -----	2
5	8MP04280808A	螺絲 Screw (MT0235 M4-0.7*8) -----	3
6	2240000601S	手輪 Handwheel -----	1
7	2200000607	齒形皮帶 Timeing Belt -----	1
8	22400006081	齒形皮帶輪 Timeing Pulley -----	1
9	2200000509	平衡錘 Balance Weight -----	1
10	2200000610	套管接頭 Joint -----	1
11	90BB204714	滾珠軸承 Ball Bearing -----	1
12	2240000612	軸承套筒 Bearing Sleeve -----	1
13	2210000613	曲軸 Crank Shaft -----	1
14	90SCR150	C形軸用扣環 C Ring -----	1
15	90BB1535115	滾珠軸承 Ball Bearing -----	2
16	-----	-----	-
17	8MN06400800C	螺絲 Screw(FT05-02 M6-1*8) -----	1
18	2240000603S	迷你馬達 Mini Motor -----	1
19	2200000619	連桿 Connecting Rod -----	1
20	8MB95301407K	螺絲 Screw(CT0620 M4.5-0.75*14) -----	2
21	8MB85241006K	螺絲 Screw(CT0621 M3.5-0.6*10) -----	2
22	2200000622	定向導軌 Orient Guide -----	1
23	221A0000653	曲軸組 Crank Shaft Asm. -----	1
24	2200000624	曲柄 Ball Lever -----	1
25	8MM06401610A	螺絲 Screw (CT0625 M6-1*16) -----	4
26	8MM05321009A	螺絲 Screw (CT0626 M5-08*10) -----	1
27	2200000627	墊圈 Washer -----	1
28	2200000628	隔環 Spacer -----	1
29	2200000629	軸 Shaft -----	1
30	2200000630	承座 Bracket -----	1
31	90SW050	彈簧墊圈 Spring Washer -----	1
32	8MM05321409A	螺絲 Screw (CT0632 M5-0.8*14) -----	1
33	2200000633	針線揚線桿 Thread Take-up -----	1
34	2220000634	裝飾線揚線桿 Thread Take-up -----	1
35	8MB85240807K	螺絲 Screw (FT0555 M3.5-0.6*8) -----	2
36	8MB03200806A	螺絲 Screw (CT900623 M3-0.5*8) -----	2
37	-----	-----	-
38	2240000603M	迷你馬達 Mini Motor -----	1
39	8MN06400800A	螺絲 Screw (CT0549 M6-1*8) -----	2
40	2100001404	孔塞 Plug (S14-04)-----	1
41	66800	油線 Oil Wick -----	1
42	2240000642	聚油環 Oil Sleeve -----	1
43	66485-10	銘板 Plate -----	1
44	8MN06400600A	螺絲 Screw(CT0244 M6-1*6) -----	8
45	-----	-----	-
46	222A0000646	套管接頭組 Joint Asm -----	1
47	222A0000647	平衡錘組 Balance Weight Asm -----	1
48	222A0000648	連桿組 Connecting Rod Asm -----	1
49	-----	-----	-
50	-----	-----	-
51	8MB04280807K	螺絲 Screw (C02-15 M4-0.7*8)-----	1
52	2100000223	墊圈 Washer -----	1
53	4MN0210108	線夾 Cord Clamp-----	1
54	4UTB020306	束線Plastic Binding Wire-----	1

馬達選購 (Motor Optional) :

廠商Company	序號Ref. No.	
賀欣 Ho hsing moto	1	3
松慶規格 Shokei motor	6	18
永輝興 ISM	1	38

7. CT9000 / CX2000 / CTD9000 / CXD2000 / CXM2000

針棒與相關零件 Needle Bar Components

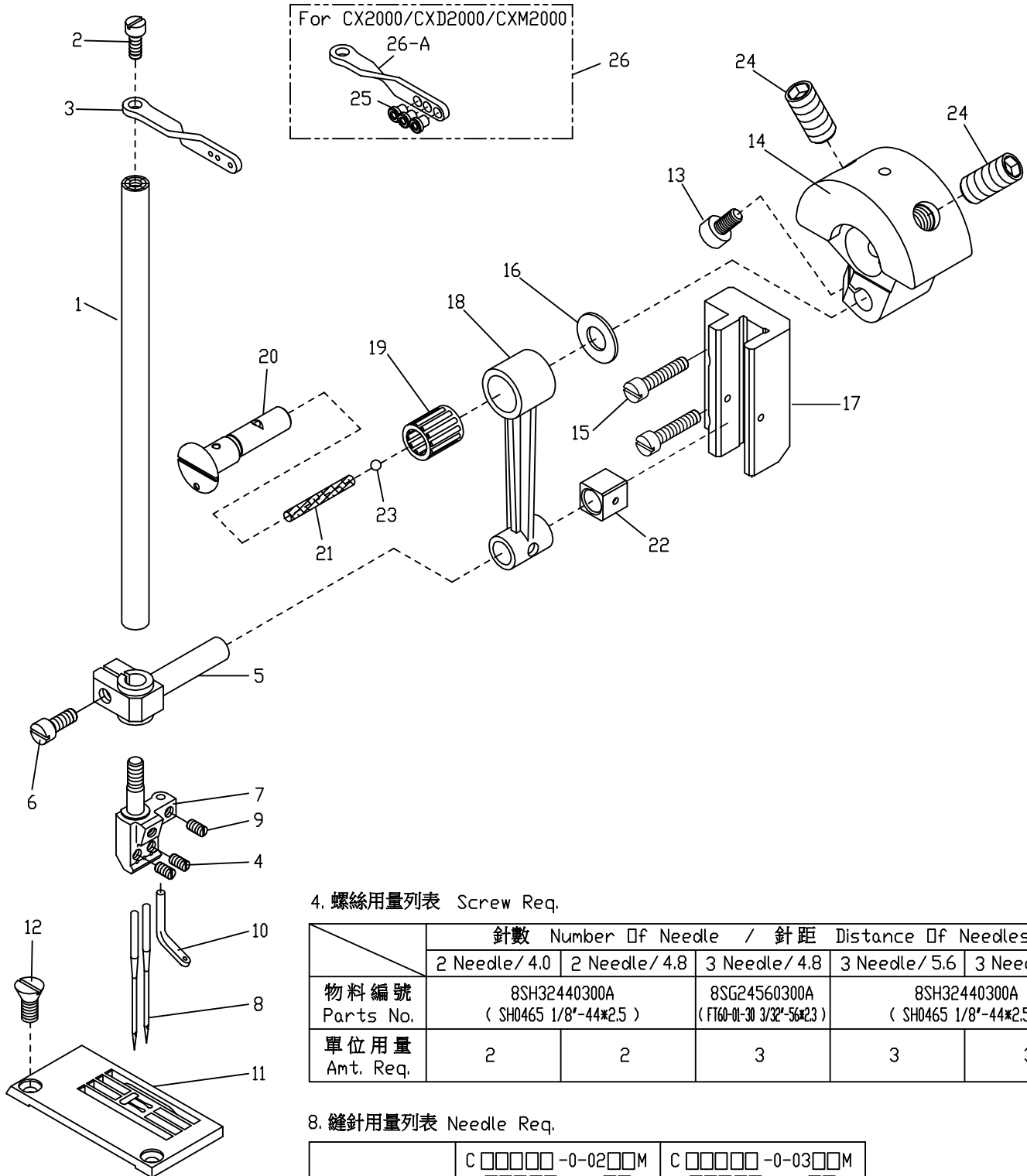

4. 螺絲用量列表 Screw Req.

	針數 Number of Needle / 針距 Distance of Needles				
	2 Needle / 4.0	2 Needle / 4.8	3 Needle / 4.8	3 Needle / 5.6	3 Needle / 6.4
物料編號 Parts No.	8SH32440300A (SH0465 1/8"-44*2.5)		8SG24560300A (FT60-01-30 3/32"-56*2.3)	8SH32440300A (SH0465 1/8"-44*2.5)	
單位用量 Amt. Req.	2	2	3	3	3

8. 縫針用量列表 Needle Req.

針號 UY128GAS 66725-11-5	C □ □ □ □ -0-02 □ □ M	C □ □ □ □ -0-03 □ □ M
	C □ □ □ □ -0-2 □ □ M	C □ □ □ □ -0-3 □ □ M
	C □ D □ □ □ -0-02 □ □ M	C □ D □ □ □ -0-03 □ □ M
	C □ D □ □ □ -0-2 □ □ M	C □ D □ □ □ -0-3 □ □ M
針數 Needle	2	3

序號 Ref.No.	名稱 Description	針數 Number of Needle / 針距 Distance of Needles				
		2 Needle / 4.0	2 Needle / 4.8	3 Needle / 4.8	3 Needle / 5.6	3 Needle / 6.4
7	針留 Needle Clamp	5220NC00400	5220NC00480	5220NC00485	5227NC00560	5227NC00640
11	針板 Needle Plate	5222TP00401	5220TP00484	5220TP00484	5220TP00564	5220TP00642

7. CT9000 / CX2000 / CTD9000 / CXD2000 / CXM2000

針棒與相關零件 Needle Bar Components

序號 Ref.No.	物料編號 Parts No.	名稱 Description	單位用量 Amt. Req.
1	22000007011	針棒 Needle Bar -----	1
2	8MB85240607K	螺絲 Screw (CT0637 M3.5-0.6*6) -----	1
3	2200000703	導線 Thread Guide -----	1
4	-----	螺絲 Screw (See Left Page) -----	-
5	2210000705	針棒驅動銷 Needle Bar Clamp -----	1
6	8MB95301107K	螺絲 Screw (CT0706 M4.5-0.75*11) -----	1
7	-----	針留 Needle clamp (See Left Page) -----	1
8	-----	針 Needle --(UY128GAS See Left Page)-----	-
9	8SH32440300A	螺絲 Screw (SH0465 1/8"-44*2.5) -----	1
*10	2200000710	導線 Thread Guide -----	1
11	-----	針板 Needle Plate (See Left Page) -----	1
12	8SF36400706C	螺絲 Screw (CT0712 9/64"-40*7.5) -----	2
13	8MM05321009A	螺絲 Screw (C06-26 M5-0.8*10) -----	1
14	2270000714	平衡錘 Balance Weight -----	1
15	8MB04281607A	螺絲 Screw (CT0724 M4-0.7*16) -----	2
16	2270000716	墊圈 Washer -----	1
17	2210000727	滑道 GuideBlock -----	1
18	2210000720	連桿 Connecting Rod -----	1
19	90NB081113	滾針軸承 Needle Bearing -----	1
20	2270000720	曲柄銷 Rod Pin -----	1
21	66800	油線 Oil Wick -----	1
22	2200000722	滑塊 Slide Block -----	1
23	2100001404	孔塞 Plug -----	1
24	8MN08401600E	螺絲 Screw (CT0618 M8-1*16) -----	2
△25	240013088	磁導線環 Thread Eyelet -----	3
△26	2600000703	導線組 Thread Guide Asm. -----	1
△26-A	2600000703A	導線 Thread Guide -----	1

* 具有上飾線 With top cover thread

△ CX2000 / CXD2000 / CXM2000 專用

8. CX2000 / CTD9000 / CTD9711 / CXD2000 / CXM2000 / CXD2711 壓腳與相關零件 Presser Foot Components

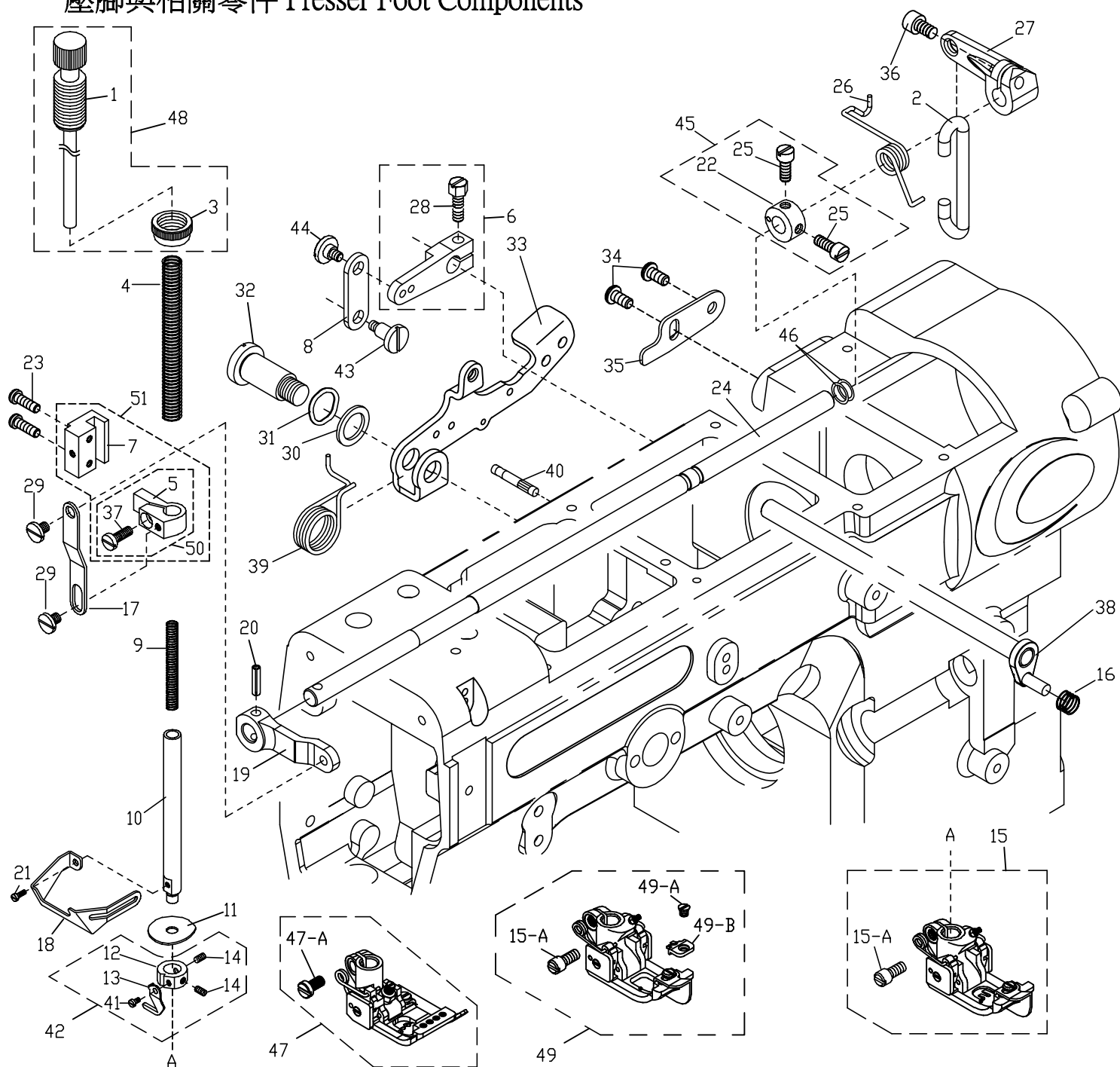

CX2000 / CTD9000 / CXD2000 / CXM2000 機型用

序號 Ref.No.	名稱 Description	針數 Number Of Needle / 針距 Distance Of Needles				
		2 Needle/4.0	2 Needle/4.8	3 Needle/4.8	3 Needle/5.6	3 Needle/6.4
15	壓腳 Presser foot asm	5220PF00404	5220PF00484	5220PF00485	5220PF00564	5220PF00644

CTD9711 / CXD2711 機型用

序號 Ref.No.	名稱 Description	針數 Number Of Needle / 針距 Distance Of Needles			
		2 Needle/4.0	3 Needle/4.8	3 Needle/5.6	3 Needle/6.4
47	壓腳 Presser foot asm	5222PF11400	5222PF11480	5222PF11560	5222PF11640

特註品 (CX2000 / CTD9000 / CXD2000 / CXM2000) 機型用

序號 Ref.No.	名稱 Description	針數 Number Of Needle / 針距 Distance Of Needles				
		2 Needle/4.0	2 Needle/4.8	3 Needle/4.8	3 Needle/5.6	3 Needle/6.4
49	壓腳 Presser foot asm	5224PF00400	5224PF00480	5224PF00481	5224PF00560	5224PF00640
49-B	壓腳舌 Presser foot tongue	5224PF0040A	5224PF0048A	5224PF00481A	5224PF0056A	5224PF0064A

8. CX2000 / CTD9000 / CTD9711 / CXD2000 / CXM2000 / CXD2711

壓腳與相關零件 Presser Foot Components

序號 Ref.No.	物料編號 Parts No.	名稱 Description	單位用量 Amt. Req.
1	2220000801	壓力調整螺椿 Spring Regulator -----	1
2	2240000802	吊桿 Lifter Connecting Plate -----	1
3	2220000803	螺帽 Nut -----	1
4	2200000804	彈簧 Spring -----	1
5	2200000805	壓腳棒連結臂 Presser Bar Clamp -----	1
*6	2240000806	曲柄 Drive Arm -----	1
7	2200000807	滑道 Guide Block -----	1
*8	2240000808	連桿 Link -----	1
9	2200000809	彈簧 Spring -----	1
10	2200000810	壓腳棒 Presser Bar -----	1
11	2200000811	阻油片 Oil Separator -----	1
12	2220000812	限動環 Stop Collar -----	1
13	2220000813	固定切刀 Knife -----	1
14	8MH85240300A	螺絲 Screw (CT0813 M3.5-0.6*3) -----	2
15	-----	CTD9000壓腳 Presser Foot(See Left Page) -----	1
15-A	5220PF0356M	螺絲 Screw (M3.5-0.6*8) -----	1
*16	4UTB000411	彈簧 Spring -----	1
17	2200000817	連桿 Link -----	1
18	2220000818	護指擋片 Safety Plate Holder -----	1
19	2240000819	連桿 Lever -----	1
20	90SP0416	彈簧銷 Spring Pin -----	1
21	8MB85240607K	螺絲 Screw (CT0637 M3.5-0.6*6) -----	1
22	2200000822	定位環 Collar -----	1
23	8MB95301407K	螺絲 Screw (CT0620 M4.5-0.75*14) -----	2
24	22400008241	軸 Shaft -----	1
25	8MC95300606F	螺絲 Screw (CT0823 M4.5-0.75*5.5) -----	2
26	2240000826	彈簧 Spring -----	1
27	2240000827	連桿 Link -----	1
28	8MK95301407A	螺絲 Screw (CT0837 M4.5-0.75*14) -----	1
29	8MB05320509G	螺椿 Stud (CT0802 M5-0.8*5) -----	2
30	2310001012	墊圈 Washer -----	1
31	2310001207	波形墊圈 Corrugated Ring -----	1
32	2310001013	螺椿 Stud -----	1
33	22400008331	揚昇臂 Lifter Arm -----	1
*34	8MP06401011A	螺絲 Screw (MT0234 M6-1*10) -----	2
*35	2240000835	限位片 Stopper -----	1
36	8MM06401210A	螺絲 Screw (F1103 M6-1*12) -----	1
37	8MC95300808E	螺絲 Screw (CT0806 M4.5-0.75*8) -----	1
*38	2240000838	軸 Shift -----	1
39	2240000839	彈簧 Spring -----	1
40	2310001017	銷 Pin -----	1
41	8MB03200405A	螺絲 Screw (FT0548 M3-0.5*4) -----	1
42	222A0000842	限動環組 Stop Collar Asm -----	1
*43	2310000343	螺椿 Stud -----	1
*44	2310000344	螺椿 Stud -----	1
45	220A0000825	定位環組 Collar Asm.-----	1
46	2240000846	O形油環 O Ring -----	2
47	-----	CTD9711壓腳 Presser Foot(See Left Page) -----	1
47-A	8MB85240605A	螺絲 Screw (CT1002 M3.5-0.6*6)-----	1
48	222A0000843	壓力調整螺椿組 Spring Regulator Set -----	1
◎49	-----	壓腳 Presser Foot -----	1
◎49-A	5221PF6056C	螺絲 Screw -----	1
◎49-B	-----	壓腳舌 Press Foot Tongue -----	1
50	220A0000843	壓腳棒連結臂組 Presser Bar Clamp Set -----	1
51	220A0000844	滑道組 Guide Block Set -----	1

* 為標準型專用，切線 (UT 系列) 時不使用

* For basic model only. Not applicable to thread trimmer (UT series) series.

◎ 特註品 Custom-made Item

9. CT9000 / CT9711 / CX2000 / CTD9000 / CTD9711 / CXD2000 / CXM2000
 CXD2711 裝飾線驅動機構 Spreader Mechanism

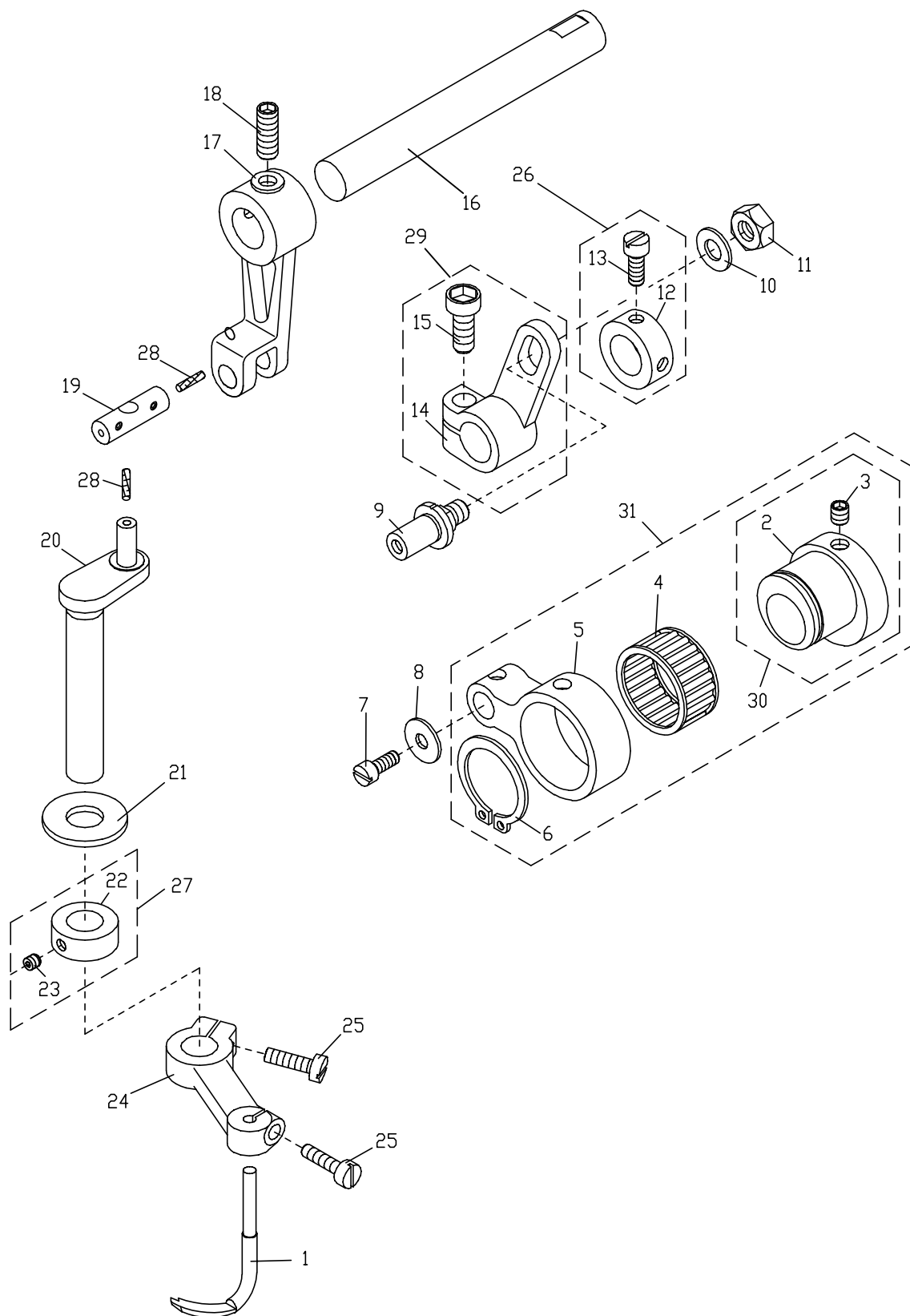

9. CT9000 / CT9711 / CX2000 / CTD9000 / CTD9711 / CXD2000 / CXM2000

CXD2711 裝飾線驅動機構 Spreader Mechanism

序號 Ref.No.	物料編號 Parts No.	名稱 Description	單位用量 Amt. Req.
1	5220SL00560	裝飾線結線鉤 Spreader -----	1
2	2200000902	偏心輪 Eccentric -----	1
3	8MN05320500E	螺絲 Screw (CT0903 M5-0.8*5) -----	2
4	90NB222613	滾針軸承 Needle Bearing -----	1
5	2200000905	連桿 Connecting Rod -----	1
6	90SCR220	軸用C形扣環 C Ring -----	1
7	8MB04280807K	螺絲 Screw (CT0215 M4-0.7*8) -----	1
8	2200000908	墊圈 Washer -----	1
9	2200000909	曲柄銷 Rod Pin -----	1
10	2200000910	墊圈 Washer -----	1
11	8MA06400510A	螺帽 Nut (CT0533 M6-1*5) -----	1
12	2200000912	定位環 Collar -----	1
13	8MC95300606F	螺絲 Screw (CT0823 M4.5-0.75*5.5) -----	2
14	2200000914	變距曲柄 Lever -----	1
15	8MM06401610A	螺絲 Screw (CT0625 M6-1*16) -----	1
16	2200000916	軸 Shaft -----	1
17	2220000917	連桿 Connecting Rod -----	1
18	8MN06400600A	螺絲 Screw (CT0244 M6-1*6) -----	2
19	2220000919	連桿銷 Rod Pin -----	1
20	2220000920	曲軸 Crank Shaft -----	1
21	2200000921	墊圈 Washer -----	1
22	2200000922	定位環 Collar -----	1
23	8MN85240300A	螺絲 Screw (UH0302 M3.5-0.6*3) -----	2
24	22000009241	擺動臂 Spreader Arm -----	1
25	8MB04281207K	螺絲 Screw (CT0239 M4-0.7*12) -----	2
26	220A0000926	定位環組 Collar Asm -----	1
27	220A0000927	定位環組 Collar Asm -----	1
28	66801	油線 Oil Wick -----	2
29	222A0000929	變距曲柄 Lever -----	1
30	222A0000930	偏心輪組 Collar Asm -----	1
31	222A0000931	偏心輪組 Collar Asm -----	1

10. CT9000 / CTD9000 / CTU9011 結線鉤驅動機構 Looper Driving Mechanism

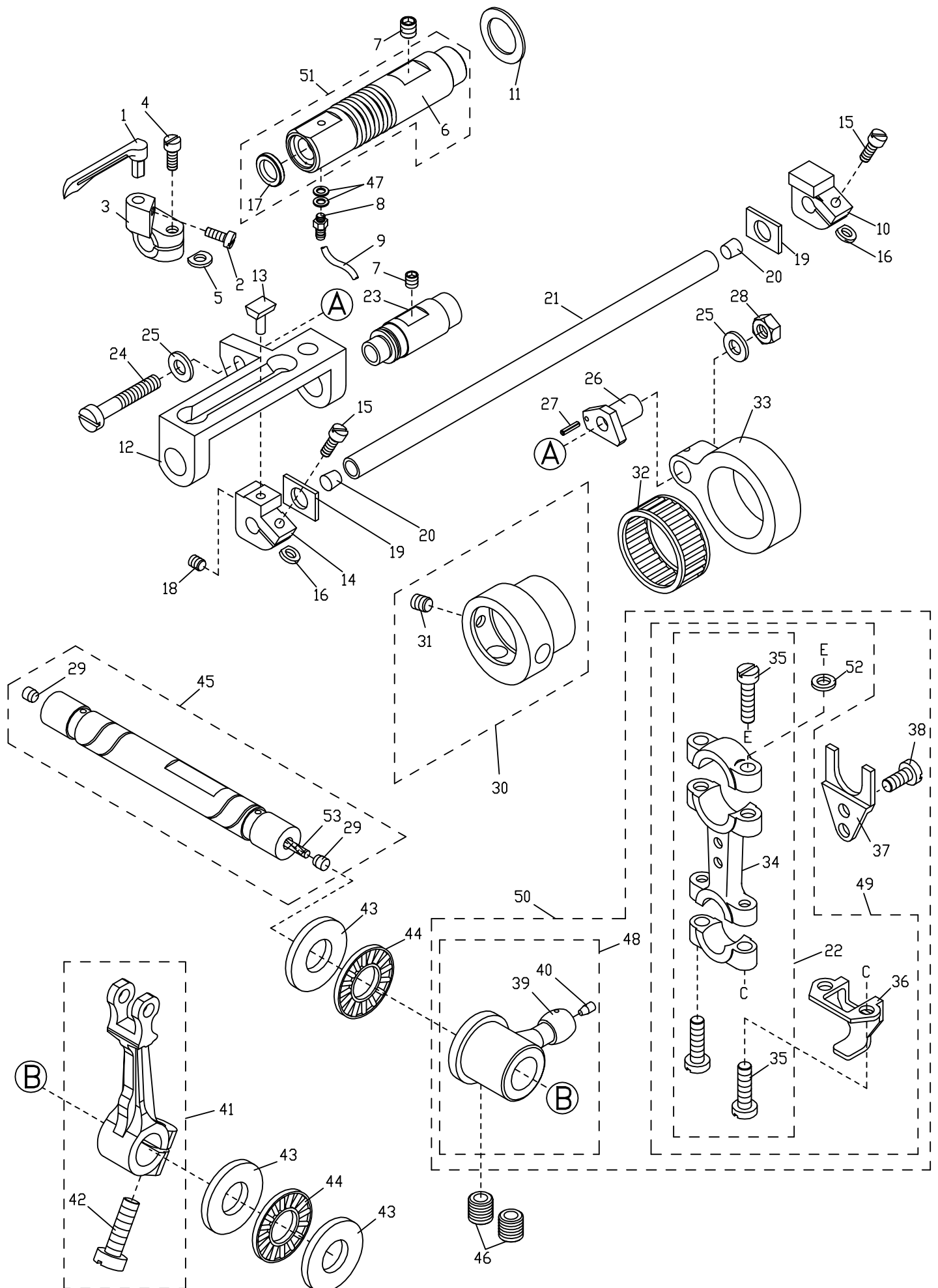

10. CT9000 / CTD9000 / CTU9011 結線鉤驅動機構 Looper Driving Mechanism

序號 Ref.No.	物料編號 Parts No.	名稱 Description	單位用量 Amt. Req.
1	5220LL00560	下結線鉤 Looper -----	1
2	8MB85240605A	螺絲 Screw (CT1002 M3.5--0.6*6) -----	1
3	2200001003	結線鉤座 Looper Holder -----	1
4	8MB85241006K	螺絲 Screw (CT0621 M3.5-0.6*10) -----	1
5	2200001005	墊圈 Washer -----	1
6	22200010063	軸襯 Bushing -----	1
7	8MN06400600A	螺絲 Screw (CT0244 M6-1*6) -----	2
8	2100001505	油嘴 Oil Tube Joint (SH1505) -----	1
9	66790	油管 Oil Tube (Ø2.9 * Ø5 * 120 L)-----	1
10	2220001010	滑塊固定座 Slider Holder -----	1
11	2200001011	墊圈 Washer -----	1
12	22200010121	滑道 Guide Block -----	1
13	2200001013	滑塊 Slide block -----	1
14	2200001014	滑塊固定座 Slider Holder -----	1
15	8MB85241106A	螺絲 Screw (CT1015 M3.5-0.6*11) -----	2
16	2200001016	墊圈 Washer -----	2
17	22700010171	油封 Oil Seal -----	1
18	8MN04280400A	螺絲 Screw (CT0229 M4-0.7*4) -----	1
19	2200001019	止推墊片 Thrust Plate -----	2
20	22000002471	孔塞 Plug -----	2
21	2220001021	結線鉤驅動軸 Looper Drive Bar -----	1
22	220A0001022	連桿組 Connecting Rod Asm -----	1
23	22200010231	軸襯 Bushing -----	1
24	8MB05323009B	螺絲 Screw (CT1024 M5-0.8*30) -----	1
25	2200001025	墊圈 Washer -----	2
26	2200001026	變距連桿銷 Adjusting Pin -----	1
27	2200001027	彈簧銷 Spring Pin -----	1
28	8MA05320408A	螺帽 Nut (CT1028 M5-0.8*4) -----	1
29	2200001029	孔塞 Plug -----	2
30	2200001030	偏心輪 Eccentric -----	1
31	8MN05320500E	螺絲 Screw (CT0903 M5-0.8*5) -----	1
32	90NB263013	滾針軸承 Needle Bearing -----	1
33	2200001033	連桿 Rod -----	1
34	2200001034	連桿 Connecting Rod -----	1
35	8MB95301407K	螺絲 Screw (CT0620 M4.5-0.75*14) -----	4
36	2200001036	潑油片 Oil Splasher -----	1
37	2200001037	定向導片 Orient Guide -----	1
38	8MB95301008A	螺絲 Screw (SS033-01-16 M4.5-0.75*10) -----	2
39	22000010391	曲柄 Lever -----	1
40	2100000328	孔塞 Plug -----	1
41	2260001041	擺動臂 Rocker Arm -----	1
42	8MM06401610A	螺絲 Screw (CT0625 M6-1*16) -----	1
43	2200001043	止推墊圈 Thrust Washer -----	3
44	2200001044	止推軸承 Thrust Bearing -----	2
45	2200001045	軸 Shaft -----	1
46	8MN08500800A	螺絲 Screw (CT10461 M8-1.25*8) -----	2
47	2200001047	墊圈 Washer -----	2
48	220A0001048	曲柄組 Lever Asm -----	1
49	220A0001049	連桿組 Connecting Rod Asm -----	1
50	220A0001050	連桿組 Connecting Rod Asm -----	1
51	227A00010511	軸襯組 Bushing Asm. -----	1
52	2100000640	墊圈 Washer -----	2
53	66800	油線 Oil Wick -----	1

11. CT9000 / CTD9000 / CTU9011 進給變換機構 Feed Control Driving

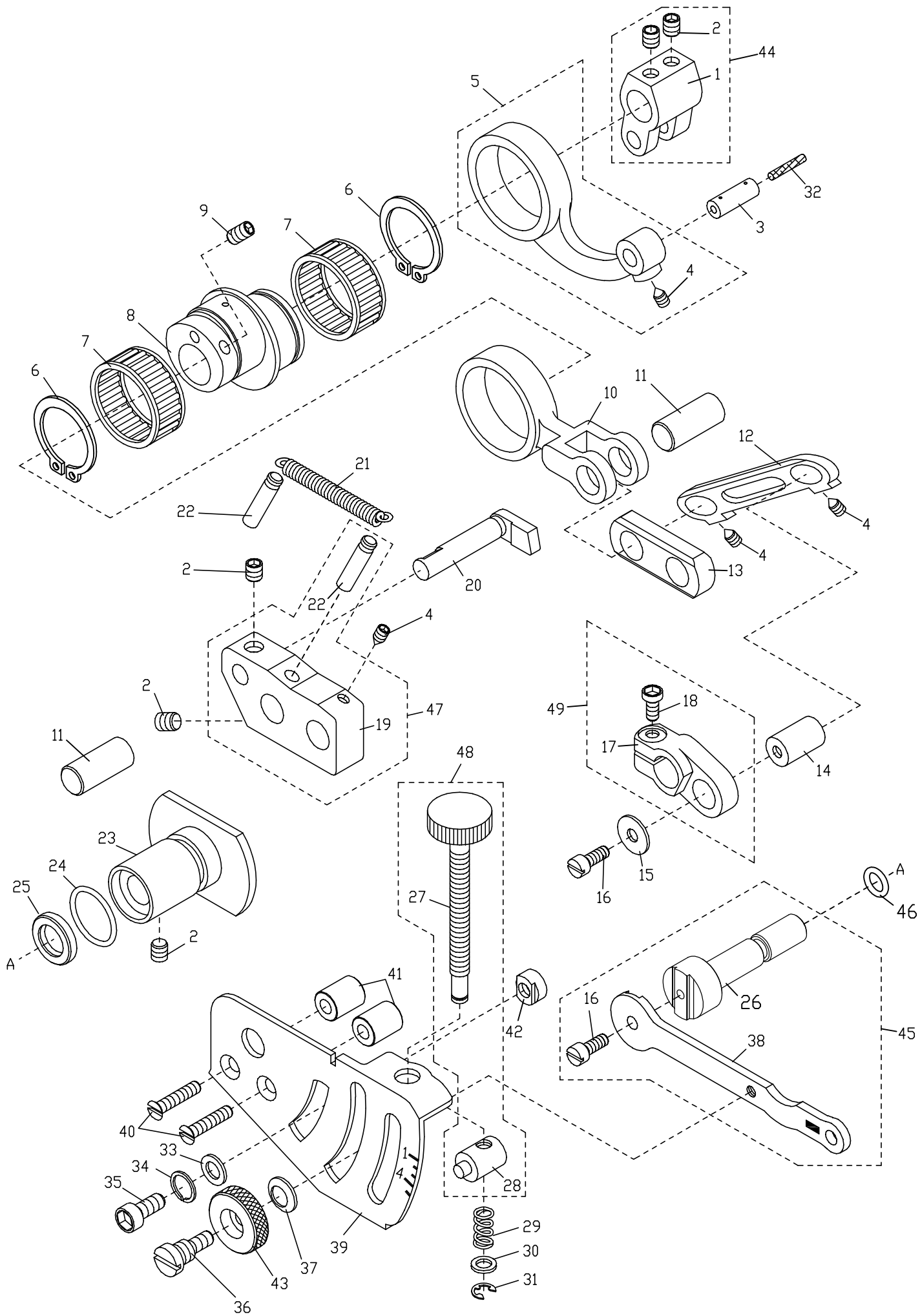

11. CT9000 / CTD9000 / CTU9011 進給變換機構 Feed Control Driving

序號 Ref.No.	物料編號 Parts No.	名稱 Description	單位用量 Amt. Req.
1	2200001101	曲柄 Lever -----	1
2	8MN06400600A	螺絲 Screw (CT0244 M6-1*6) -----	5
3	2200001103	曲柄銷 Rod Pin -----	1
4	8MN04280600C	螺絲 Screw (CT1104 M4-0.7*6) -----	4
5	2200001105	連桿 Rod -----	1
6	2200001106	C形軸用扣環 C Ring -----	2
7	90NB252910	滾針軸承 Needle Bearing -----	2
8	2200001108	偏心輪 Eccentric -----	1
9	8MN05320500E	螺絲 Screw (CT0903 M5-0.8*5) -----	2
10	2200001110	連桿 Rod -----	1
11	2200001111	連桿銷 Rod Pin -----	2
12	2200001112	連桿 Link -----	1
13	2200001113	連桿 Link -----	1
14	2200001114	曲柄銷 Lever Pin -----	1
15	2200001115	墊圈 Washer -----	1
16	8MB04280807K	螺絲 Screw (CT0215 M4-0.7*8) -----	2
17	2200001117	曲柄 Lever -----	1
18	8MM04281207A	螺絲 Screw (CT0202 M4-0.7*12) -----	1
19	2220001119	承座 Bracket -----	1
20	2200001120	懸臂式滑軌 Guide -----	1
21	22000011211	彈簧 Spring -----	1
22	2200001122	彈簧掛鉤 Pin -----	2
23	2200001123	軸襯 Bushing -----	1
24	90OR160	O形油環 O Ring -----	1
25	2200001125	油封 Oil Seal -----	1
26	2220001126	差動游標軸 Shaft -----	1
27	2220001127	調節螺樁 Adjusting Screw -----	1
28	2220001128	微調定位銷 Differential Feed Block -----	1
29	2220001129	彈簧 Spring -----	1
30	2220001130	墊圈 Washer -----	1
31	90ER040	E形扣環 -----	1
32	66800	油線 Oil Wick -----	1
33	2200001025	墊圈 Washer -----	1
34	90SW050	彈簧墊圈 Spring Washer -----	1
35	8MM05320809A	螺絲 Screw (CT1145 M5-0.8*8) -----	1
36	8MB06401108Q	螺樁 Stud (CT1146 M6-1*11) -----	1
37	2200001137	皿形墊圈 Disc Washer -----	1
38	2220001138	差動變換桿 Lever -----	1
39	2220001139	差動刻記板 Regulator Plate -----	1
40	8ME04282208A	螺絲 Screw (NCT1140 M4-0.7*22) -----	2
41	2220001141	隔環 Spacer -----	2
42	2200001142	止動環 Stopper -----	1
43	2200001147	螺帽 Nut -----	1
44	220A0001149	曲柄組 Lever Asm. -----	1
45	222A0001145	差動變換桿組 Lever Set -----	1
46	90OR070	O形油環 O Ring -----	1
47	222A0001147	承座組 Bracket Set -----	1
48	222A0001148	調節螺樁組 Adjusting Screw Set -----	1
49	220A0001154	曲柄組 Lever Set -----	1

12. CT9000 / CTD9000 / CTU9011 導針與送布齒驅動機構

Needle Guide And Feed Dog Driving For CT9000 / CTD9000 / CTU9011

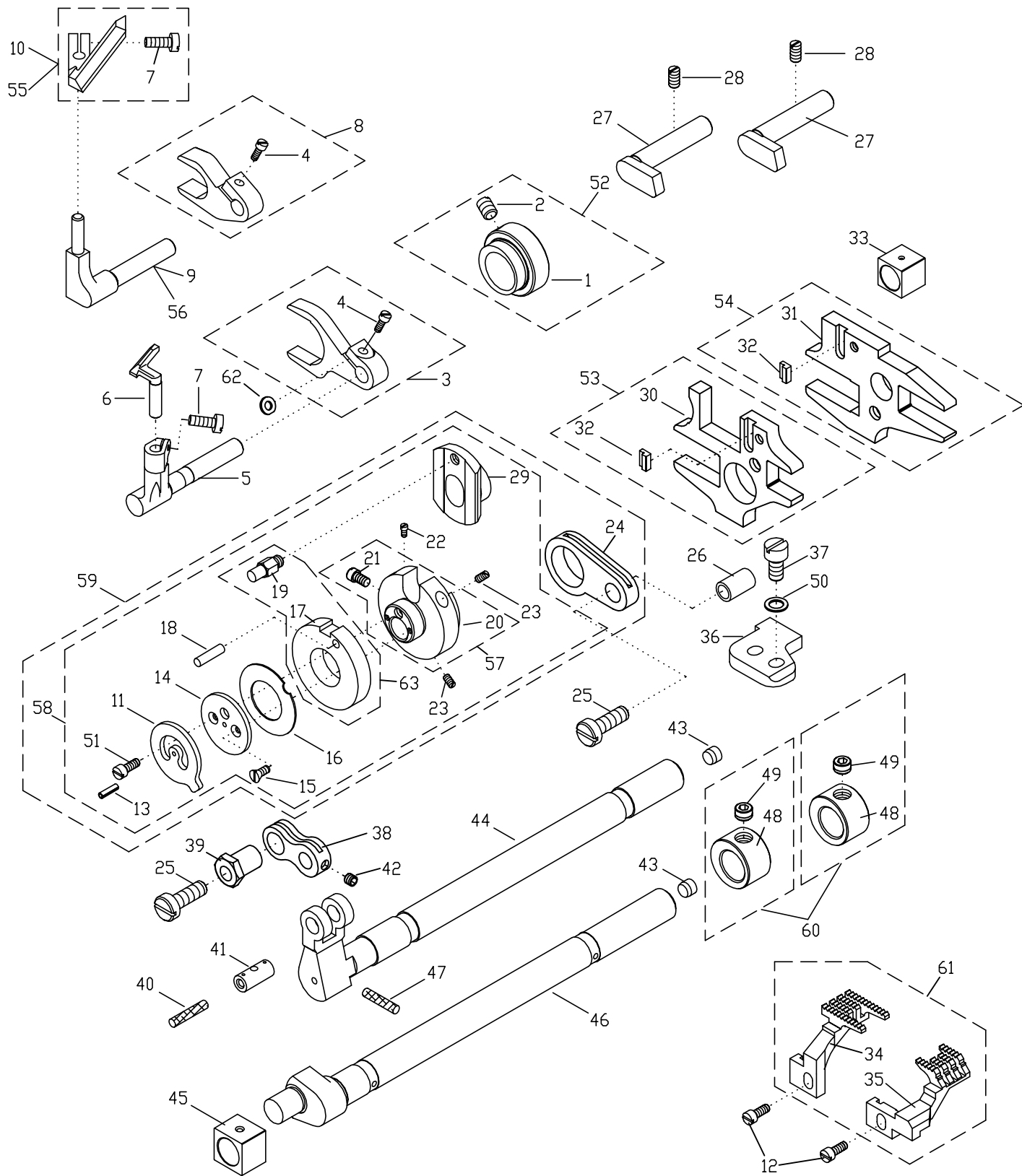

序號 Ref.No.	名稱 Description	針距 Distance Of Needles			
		4.0	4.8	5.6	6.4
34	主送布齒 Main Feed Dog	5220FD00563	5220FD00563	5220FD00563	5220FD00643
35	副送布齒 Diff Feed Dog	5220DF00560	5220DF00560	5220DF00560	5220DF00640
61	送布齒組 Feed Dog Asm.	5220DG0016	5220DG0016	5220DG0016	5220DG0017

12. CT9000 / CTD9000 / CTU9011 導針與送布齒驅動機構

Needle Guide And Feed Dog Driving For CT9000 / CTD9000 / CTU9011

序號 Ref.No.	物料編號 Parts No.	名稱 Description	單位用量 Amt.Req.
1	2200001201	導針擺動凸輪 Eccentric Cam	1
2	8MN05320500E	螺絲 Screw (CT0903 M5-0.8*5)	2
3	2200001203	導針擺動曲柄 Lever	1
4	8MB03201006A	螺絲 Screw (CT1204 M3-0.5*10)	2
5	2200001205	前導針座 Needle Guide Holder	1
6	5220NG00563	前導針器 Needle Guide	1
7	8MB03200606K	螺絲 Screw (CT1207 M3-0.5*6)	2
8	2200001208	導針擺動曲柄 Lever	1
9	2200001251	後導針座 Needle Guide Holder	1
10	5220NG00562	後導針器 Needle Guide	1
11	2200001211	限動片 Stopper	1
12	8MB85240806K	螺絲 Screw (CT0635 M3.5-0.6*8)	2
13	2200001027	彈簧銷 Spring Pin	1
14	2200001214	壓板 Presser	1
15	8ME02160404A	螺絲 Screw (CT0215 M2-0.4*4)	2
16	2200001216	緊迫簧片 Disc Spring	1
17	2200001217	變距凸輪 Cam	1
18	90SP0308	止動銷 Stopper Pin	1
19	2200001219	引動銷 Drive Pin	1
20	2200001220	變距滑道 Slide Guide	1
21	8MB85240605K	螺絲 Screw (CT1221 M3.5-0.6*6)	1
22	8MN03200300A	螺絲 Screw (CT0115 M3-0.5*3)	1
23	8MN04280600A	螺絲 Screw (CT1223 M4-0.7*6)	2
24	2200001224	連桿 Link	1
25	8MB05321809K	螺絲 Screw (CT1225 M5-0.8*17.8)	2
26	2200001226	連桿銷 Pin	1
27	2200001227	懸臂式滑軌 Guide	2
28	8MN06400600A	螺絲 Screw (CT0244 M6-1*6)	2
29	2200001229	變距滑塊 Slide Block	1
30	2200001230	主送齒驅動座 Feed Dog Seat	1
31	22000012311	副送齒驅動座 Feed Dog Seat	1
32	2200001232	送布齒定位鍵 Locator Key	2
33	2200001233	滑塊 Slide Block	1
34	-----	主送布齒 Main Feed Dog(See Left Page)	1
35	-----	副送布齒 Diff.Feed Dog(See Left Page)	1
36	2200001236	送齒座側導塊 Guide Block	1
37	8MB04281007K	螺絲 Screw(CT1237 M4-0.7*10)	2
38	2200001238	連桿 Link	1
39	2200001239	連桿銷 Pin	1
40	66800	油線 Oil Wick	1
41	2200001241	連桿銷 Pin	1
42	8MN03200400C	螺絲 Screw (CT1242 M3-0.5*4)	1
43	2200001243	孔塞 Plug	2
44	2200001244	曲柄 Shaft	1
45	2200001245	滑塊 Slide Block	1
46	2200001246	曲軸 Crank Shaft	1
47	66802	油線 Oil Wick	1
48	2200001248	定位環 Collar	2
49	8MN06400400A	螺絲 Screw (FT39-04-41 M6-1*4)	2
50	2100000223	墊圈 Washer	2
51	8MB85240807K	螺絲 Screw (FT0555 M3.5-0.6*8)	1
52	222A0001252	導針擺動凸輪組 Eccentric Cam Asm	1
53	222A0001253	主送齒驅動座組 Feed Dog Seat Asm	1
54	222A0001254	副送齒驅動座組 Feed Dog Seat Asm	1
*55	5220NG00561	後導針器 Needle Guide	1
*56	2200001209	後導針座 Needle Guide Holder	1
57	220A0001256	變距滑道組 Slide Guide Asm	1
58	220A0001254	變距滑道組 Slide Guide Asm	1
59	220A0001255	變距滑道組 Slide Guide Asm	1
60	220A0001252	定位環組 Collar Asm	2
61	-----	送布齒組 Feed Dog Asm. (See Left Page)	1
62	90PW030708	墊圈 Washe	1
63	220A0001263	變距凸輪組 Cam Set	1

*特註品 Custom-Item

13. CTD9000 潤滑系統 Lubrication System For CTD9000

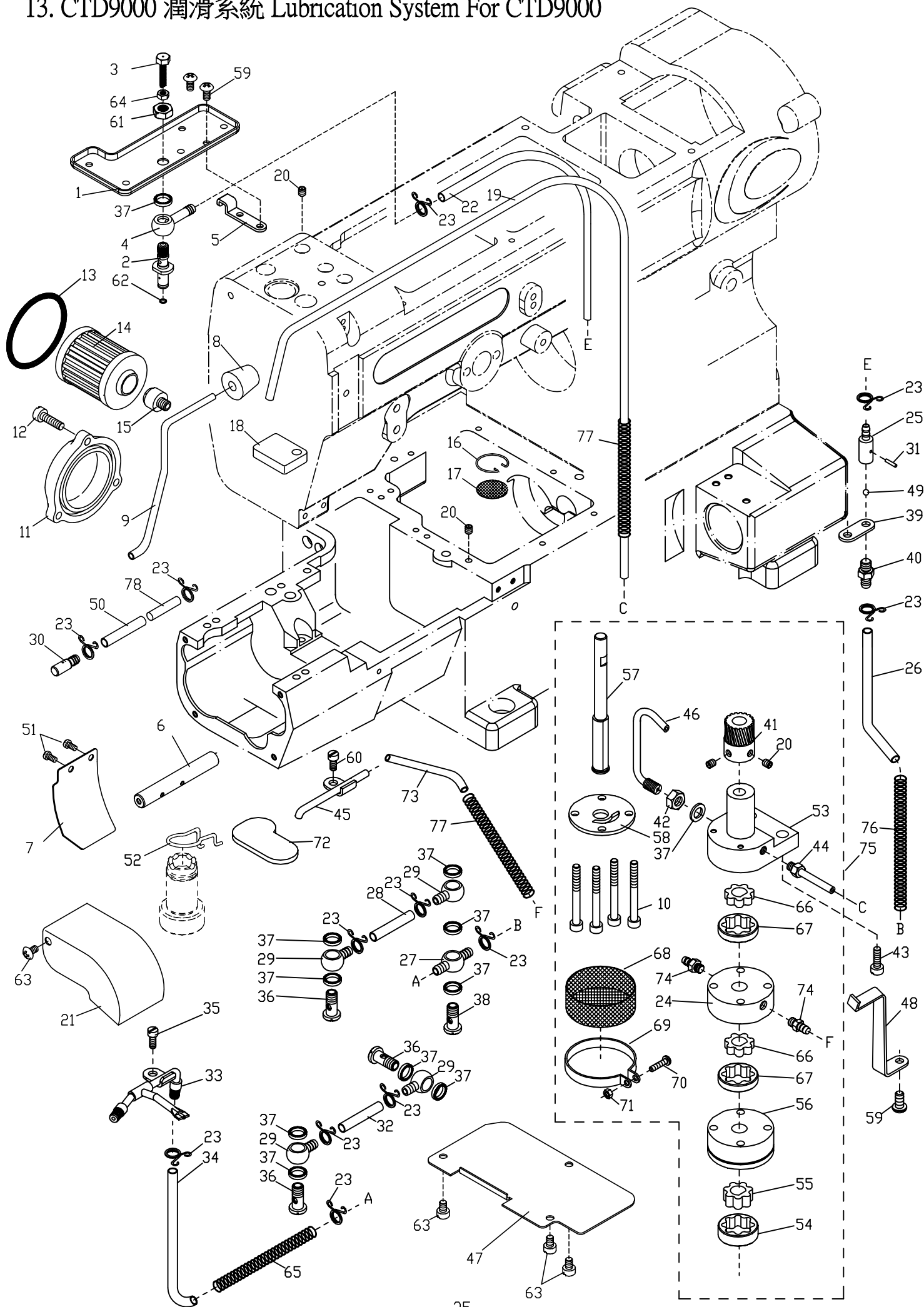

13. CTD9000 潤滑系統 Lubrication System For CTD9000

序號 Ref. No.	物料編號 Parts No.	名稱 Description	單位用量 Amt. Req.
1	2240001301	承油盤 Oil Receiver -----	1
2	2240001302	油管 Oil Tube -----	1
3	2240001303	噴油嘴 Nozzle -----	1
4	2240001304	油管接頭 Oil Tube Joint -----	1
5	22400013051	檔片 Washer -----	1
6	2210001352	軸 Shaft -----	1
7	2210001353	防油蓋 Cover -----	1
8	2210001311	孔塞 Plug -----	1
9	2210001310	油線 Oil Tube -----	1
10	8MM04284007B	螺絲 Screw (CT1310 M4-0.7*40) -----	4
11	2200001311	封蓋 Oil Filter Cover -----	1
12	8MB04281207K	螺絲 Screw (CT0239 M4-0.7*12) -----	3
13	2200001313	O 形油環 O Ring -----	1
14	2100001521	過濾器 Oil Filter -----	1
15	2200001315	過濾器接頭 Oil Filter Joint -----	1
16	2200001316	扣簧 Filter Screen Clamp -----	1
17	2200001317	網板 Filter Screen -----	1
18	2200001318	羊毛氈 Felt -----	1
19	66790	油管 Oil Tube ($\varnothing 2.9 * \varnothing 5 * 410 L$) -----	1
20	8MN04280400A	螺絲 Screw(CT0229 M4-0.7*4) -----	4
21	2210001354	防油蓋 Cover -----	1
22	66792	油管 Oil Tube ($\varnothing 4.6 * \varnothing 6.3 * 420 L$)-----	1
23	2100001536	夾簧 Latch Spring -----	12
24	2220001324	壓出泵 Rotor Case -----	1
25	2220001325	單向閥 One Way Valve -----	1
26	66792	油管 Oil Tube ($\varnothing 4.6 * \varnothing 6.3 * 110 L$)-----	1
27	2200001327	油管接頭 Oil Tube Joint -----	1
28	66792	油管 Oil Tube ($\varnothing 4.6 * \varnothing 6.3 * 35 L$)-----	1
29	2100001535	油管接頭 Oil Tube Joint -----	4
30	2200001330	噴油嘴 Nozzle -----	1
31	2220001331	銷 Pin -----	1
32	66792	油管 Oil Tube ($\varnothing 4.6 * \varnothing 6.3 * 30 L$)-----	1
33	22000013331	油管 Oil Tube -----	1
34	66792	油管 Oil Tube ($\varnothing 4.6 * \varnothing 6.3 * 105 L$)-----	1
35	8MB04280807K	螺絲 Screw (CT0215 M4-0.7*8) -----	1
36	2100001533	螺樁 Stud -----	3
37	2100001534	墊圈 Washer -----	11
38	2200001338	螺樁 Stud -----	1
39	2220001339	止回閥座 Bracket -----	1
40	2220001340	油嘴 Oil Tube Joint -----	1

13. CTD9000 潤滑系統 Lubrication System For CTD9000

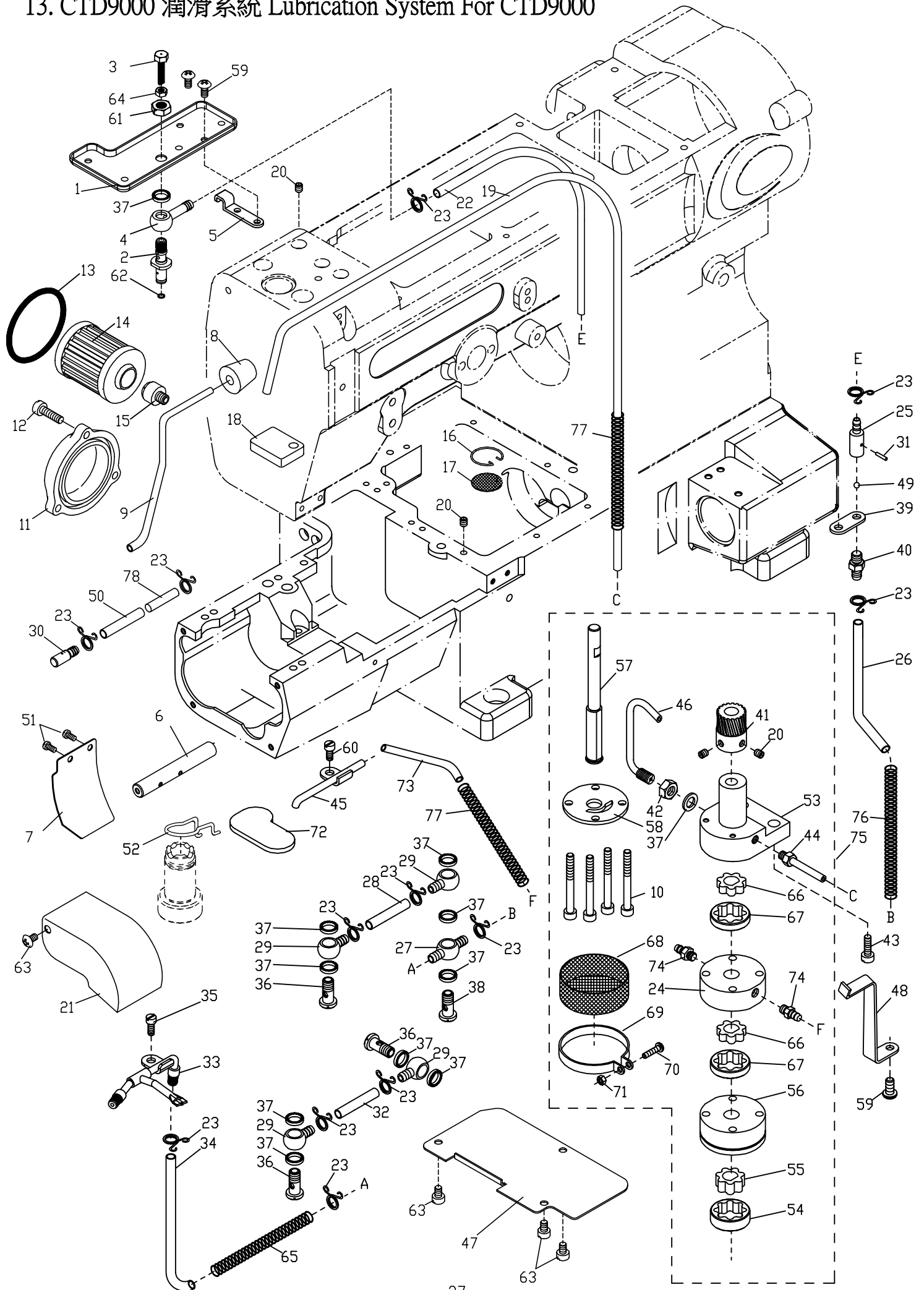

13. CTD9000 潤滑系統 Lubrication System For CTD9000

序號 Ref. No.	物料編號 Parts No.	名稱 Description	單位用量 Amt. Req.
41	2200001341	螺母 Worm Gear -----	1
42	8MA06400510A	螺帽 Nut (CT0533 M6-1*5) -----	1
43	8MM06402010A	螺絲 Screw (SH04-44 M6-1*20) -----	2
44	2200001344	油管 Oil Tube -----	1
45	2220001345	油管 Oil Tube -----	1
46	22200013461	噴油嘴 Nozzle -----	1
47	2220001347	隔板 Separate -----	1
48	2220001348	油管支持臂 Oil Tube Holder -----	1
49	2220001349	鋼珠 Steel ball -----	1
50	66792	油管 Oil Tube ($\varnothing 4.6 * \varnothing 6.3 * 37 L$) -----	1
51	8MB03200506K	螺絲 Screw (CT0525 M3-0.5*5) -----	2
52	2270001352	壓簧 Spring Latch -----	1
53	22200013531	回收泵 Pump Body -----	1
54	2200001354	外轉子 Outside Rotor -----	1
55	2200001355	內轉子 Inside Rotor -----	1
56	2200001356	壓出泵 Rotor Case -----	1
57	22200013571	軸 Shaft -----	1
58	2200001358	封蓋 Cover -----	1
59	8MC04280807D	螺絲 Screw (CT0130 M4-0.7*8) -----	3
60	8MB04280608A	螺絲 Screw (UTB0130 M4-0.7*6) -----	1
61	8MA06400510A	螺帽 Nut (CT0533 M6-1*5) -----	1
62	90OR030	油環 Oil Rin -----	1
63	8MC04280507D	螺絲 Screw (CT0122 M4-0.7*5) -----	4
64	8MA85240306B	螺帽 Nut (FT020112 M3.5-0.6*2.8) -----	1
65	2260001380	彈簧 Spring -----	1
66	2220001366	內轉子 Inside Rotor -----	2
67	2220001367	外轉子 Outside Rotor -----	2
68	2220001368	油網 Oil Mesh -----	1
69	2220001369	夾簧 Latch Spring -----	1
70	8MC03201306D	螺絲 Screw (UTB0335 M3-0.5*12.5) -----	1
71	8MA03200306A	螺帽 Nut(FTB0111 M3-0.5*3) -----	1
72	2220001372	羊毛氈 Felt -----	1
73	66790	油管 Oil Tube ($\varnothing 2.9 * \varnothing 5 * 520 L$)-----	1
74	2220001374	油嘴 Nozzle -----	2
75	227A0001375	泵組 Pump Asm -----	1
76	2270001377	彈簧 Spring -----	1
77	22700013781	彈簧 Spring -----	2
78	66805	羊毛氈 Felt ($\varnothing 5 * 23 L$) -----	1

14. 66707 線架 Thread Stand 66707

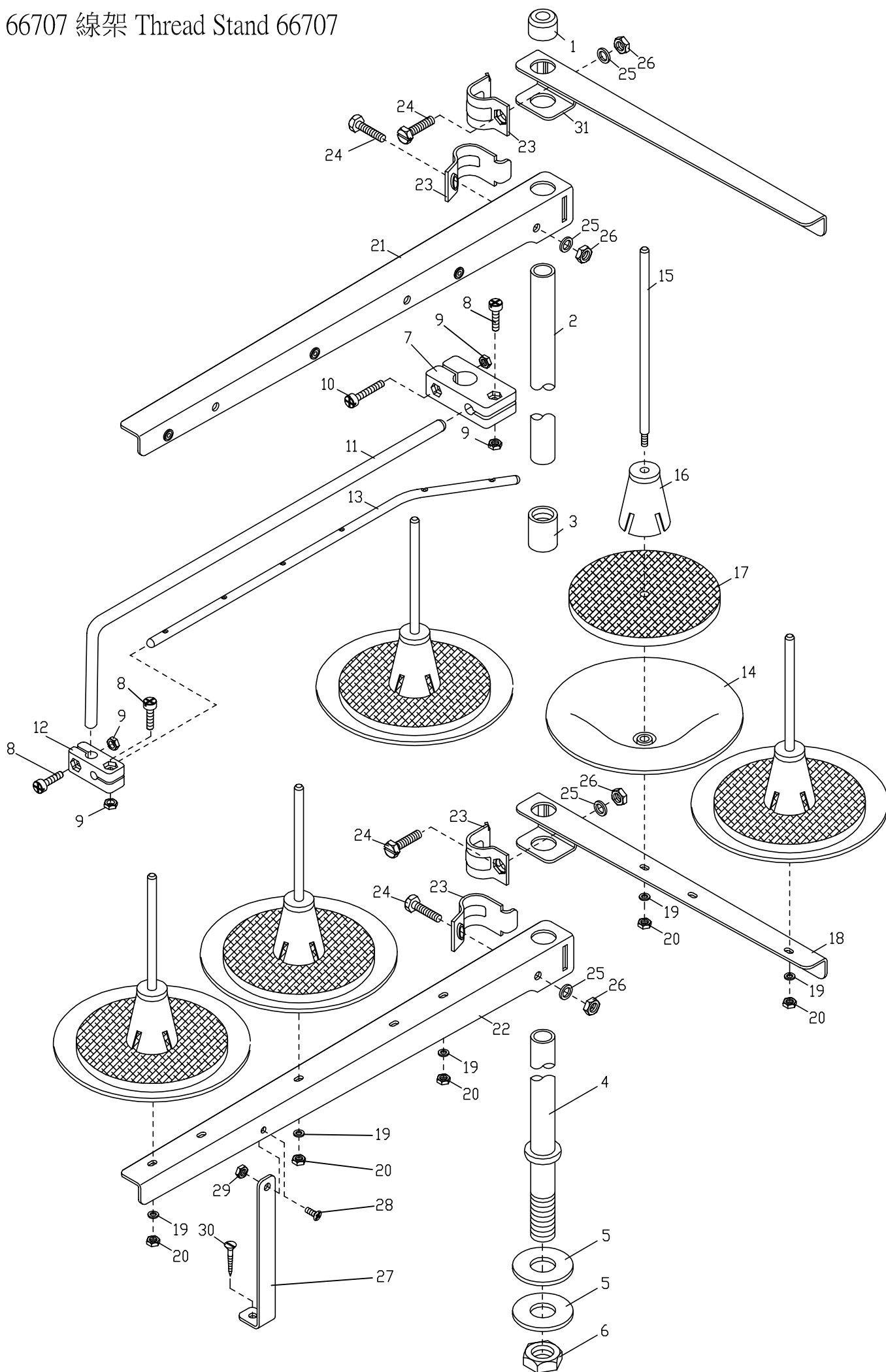

14. 66707 線架 Thread Stand 66707

序號 Ref.No.	物料編號 Parts No.	名稱 Description	單位用量 Amt. Req.
1	667051	柱帽 Rod Cup -----	1
2	667052	上柱 Upper Thread Stand Rod -----	1
3	667053	接頭 Joint -----	1
4	667054	下柱 Lower Thread Stand Rod -----	1
5	667055	墊圈 Washer -----	2
6	667056	螺帽 Nut -----	1
7	667057	接頭 Bracket -----	1
8	667058	螺絲 Screw -----	3
9	667059	螺帽 Nut -----	4
10	6670510	螺絲 Screw -----	1
11	6670511	旋臂 Arm -----	1
12	6670512	接頭 Bracket -----	1
13	6670513	導線桿 Thread Guide -----	1
14	6670514	線盤 Spool Set for SH6005 -----	5
15	6670515	線盤軸 Spool Pin -----	5
16	6670516	定心錐 Spool Retaining Fig -----	5
17	6670517	緩衝墊 Seat -----	5
18	667061	線盤座 Spool Set Bracket -----	1
19	6670519	彈簧墊圈 Spring Washer -----	5
20	6670520	螺帽 Nut -----	5
21	6670521	導線臂 Thread Guide -----	1
22	6670522	線盤座 Spool Set Bracket -----	1
23	6670523	夾板 Clamp -----	4
24	6670524	螺絲 Screw -----	4
25	6670525	彈簧墊圈 Spring Washer -----	4
26	6670526	螺帽 Nut -----	4
27	6670527	撐桿 Support Rod -----	1
28	6670528	螺絲 Screw -----	1
29	6670529	螺帽 Nut -----	1
30	6670530	木螺絲 Wood Screw -----	1
31	6670531	導線 Thread Guide -----	1

15. CTD9000 / CTU9011 / CXD2000 / CXM2000 / CXN2000 / CXU2000
 裝載附件 Supporting Board

上載式

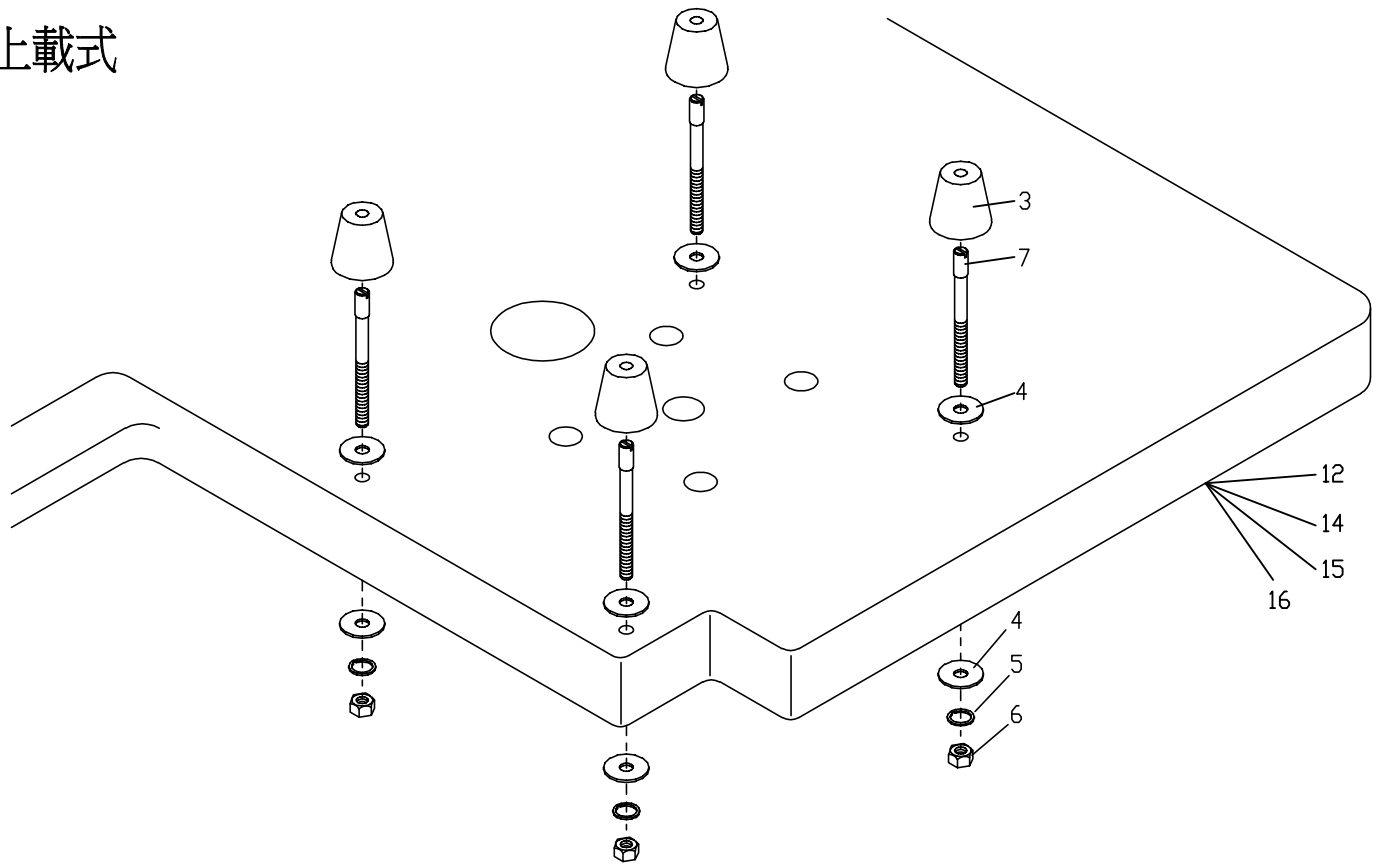

半沉式

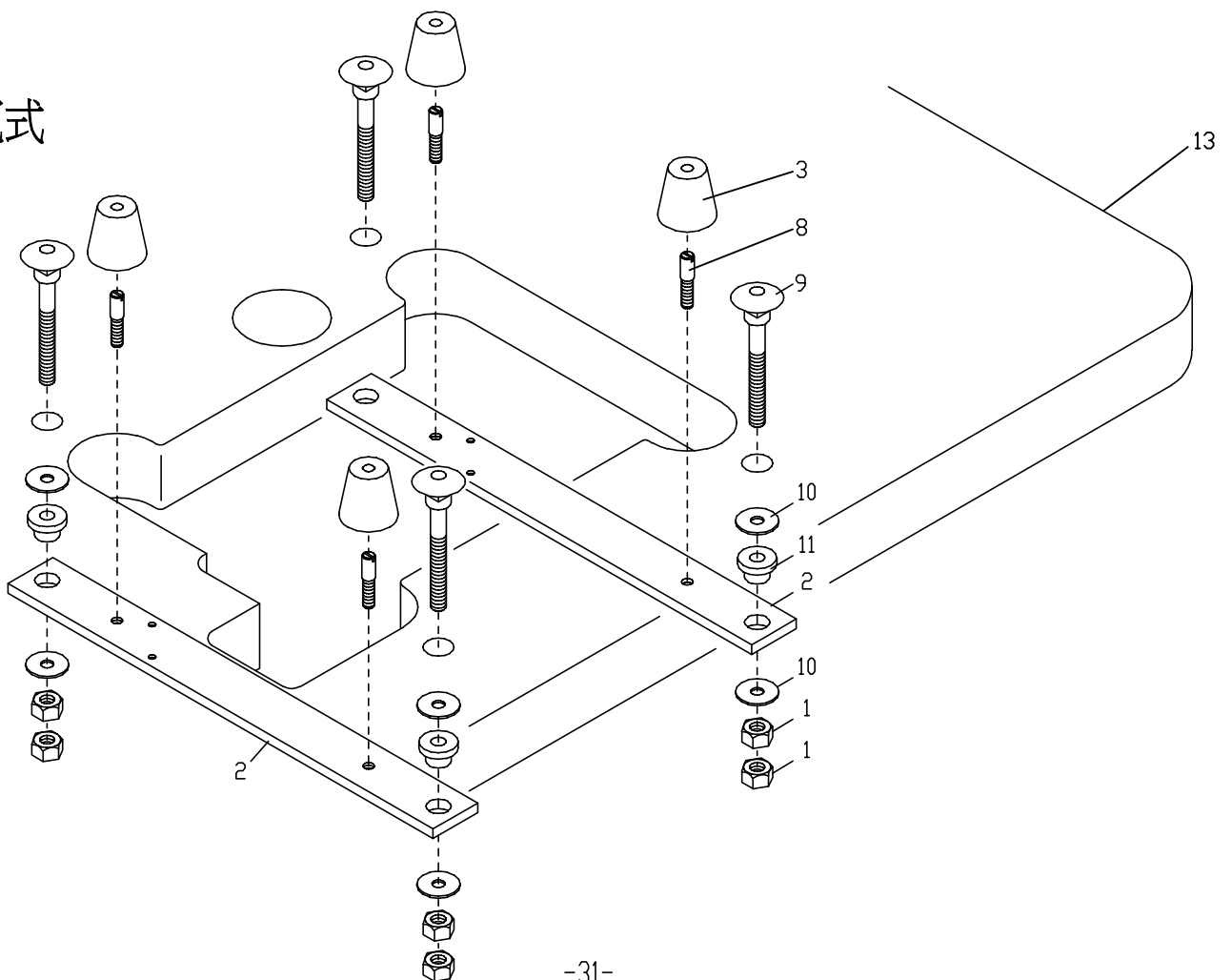

15. CTD9000 / CTU9011 / CXD2000 / CXM2000 / CXN2000 / CXU2000

裝載附件 Supporting Board

序號 Ref.No.	物料編號 Parts No.	名稱 Description	單位用量 Amt. Req.
*1	8SA79180613A	螺帽 Nut (CT1514 5/16"-18*6) -----	8
2	2200001512	車頭承板 Supporting Board -----	2
*3	66943	減震橡膠 Rubber Cushion -----	4
*4	2200001504	墊圈 Washer -----	8
*5	90SW070	彈簧墊圈 Spring Wahsher -----	4
*6	8MA06400612A	螺帽 Nut (SH0242 M6-1*6) -----	4
*7	8MB06406507B	螺椿 Bolt (CT1507 M6-1*65) -----	4
*8	8MB06401607M	螺椿 Stud (CT1503 M6-1*16) -----	4
*9	8SC79187827B	懸吊螺椿 Bolt -----	4
*10	2200001510	墊圈 Washer -----	8
*11	2200001511	橡膠環 Rubber Washer -----	4
12	66811-9	CTD9000/CTD9085/CTD9311/CTD9711/CTD9811/CXD2000/CXD2311 CXM2000/CXM2311/CXN2000/CXU2311/CXN2311 上載式開口型車板 Open-cut Table Top Type -----	-
13	66811-10	CTD9000/CXD2000/CXD2311/CXM2000/CXM2311/CXN2000/CXU2311 CXN2311 半沉式車板 Semi-submerged Type -----	-
14	66811-13	CTD9000/CTD9711/CXD2000/CXM2000 / CXN2000 上載式車板 Standard Table Top Type -----	-
15	66811-15	CTD9042 上載式開口型車板 Open-cut Table Top Type -----	-
16	66811-20	CXD2311/CXM2311/CXN2311/CXU2311 上載式車板 Standard Table Top Type -----	-
17	220A0001519	桌板螺絲包 Table Screw Package -----	1

* : 代表桌板螺絲包內的零件

16. CTD9000 / CXD2000 / CXM2000 工具及附件 Accessories

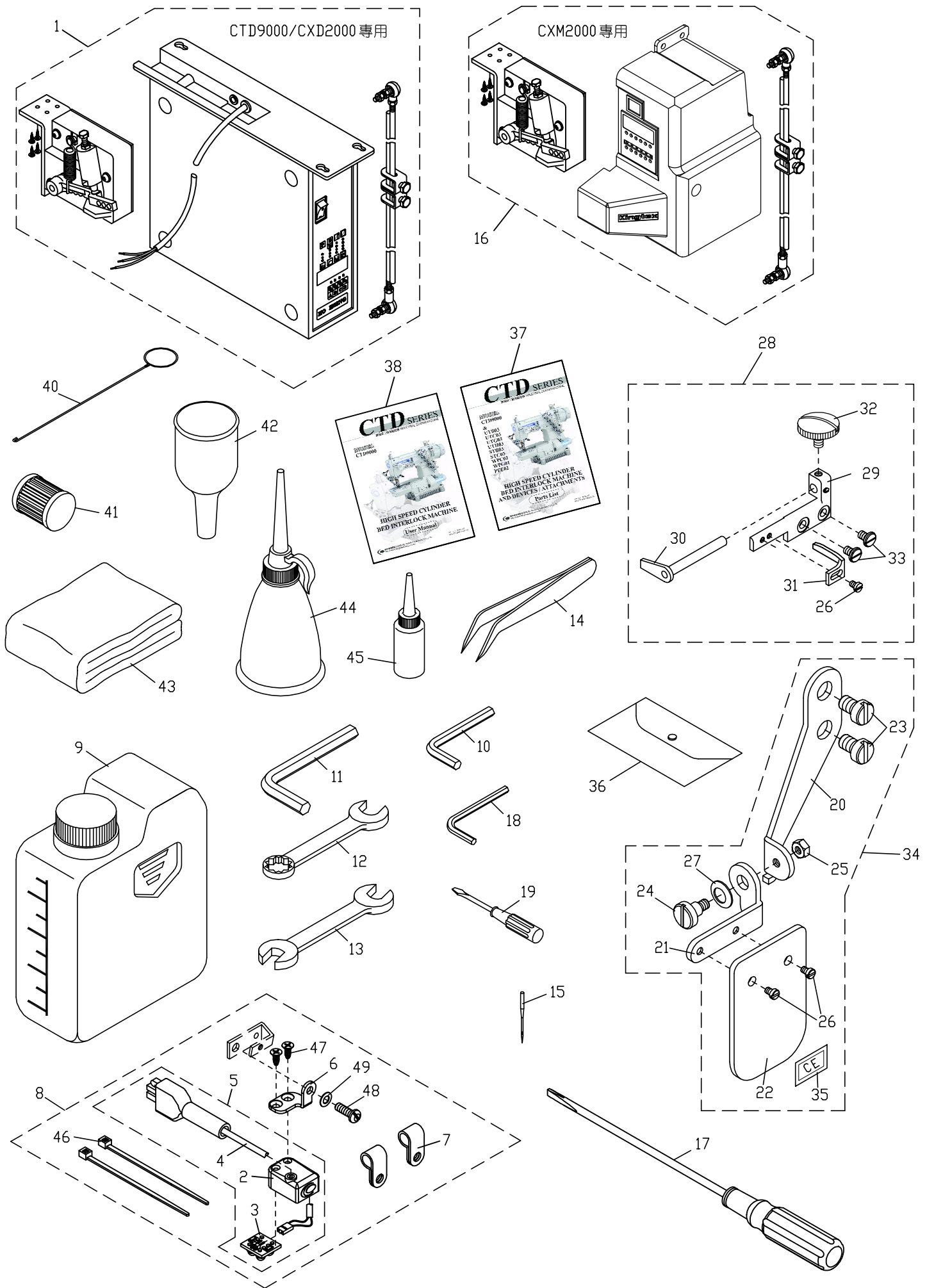

16. CTD9000 / CXD2000 / CXM2000 工具及附件 Accesseries

序號 Ref.No.	物料編號 Parts No.	名稱 Description	單位用量 Amt.Req.
*1	-----	CTD9000 / CXD2000 控制箱組 Control Box Asm. -----	1
2	2240001602	燈座 Light holder bracket -----	1
3	2240001603	燈 LED light -----	1
4	2240001604	電源線 Power connector -----	1
**5	224A0001605	燈組 Light Asm. -----	1
6	2240001606	支架 Holder Bracket -----	1
7	4UTD000254	線夾 Cord Clamp -----	2
8	/TL001	燈組 LED Light Asm. -----	-
9	66715	油罐 Oil Container -----	1
10	66636	六角扳手 Spanner 3MM -----	1
11	66637	六角扳手 Spanner 4MM -----	1
12	66612	梅花扳手 Wrench 10MM -----	1
13	66613	開口扳手 Wrench 7/8MM -----	1
14	66690	鑷子 Tweezer -----	1
15	66725-11-5	備用針 Retainer Needle -----	1
△16	-----	CXM2000 控制箱組 i60X-4-K1-220 Control Box Asm. -----	1
17	66671	木柄一字起子 Wooden Handle Flat Screw Driver -----	1
18	66639	六角板手 Spanner 1.5MM -----	1
19	66667	小起子 Screw Driver (Small) -----	1
20	2200001620	護目鏡座 Safety Plate Support -----	1
21	2200001621	護目鏡架 Safety Plate Holder -----	1
22	2200001622	護目鏡 Safety Plate -----	1
23	8MC06401008E	螺絲 Screw (CT0832 M6-1*9.5) -----	2
24	8SB36400810E	螺絲 Screw (CT1624 9/64"-40*8) -----	1
25	8SA36400306A	螺帽 Nut (K09-09 9/64"-40*3) -----	1
26	8MB03200405A	螺絲 Screw (FT0548 M3-0.5*4) -----	3
27	2200000228	墊圈 Washer -----	1
28	/EG005	導模組 Fabric Guide Asm. -----	1
29	4EG0050101	擋塊 Plate -----	1
30	4EG0050102	導模 Fabric Guide -----	1
31	4EG00501031	導模 Fabric Guide -----	1
32	4EG0050104	螺樁 Stud -----	1
33	8MB04280608A	螺絲 Screw (UTB0130 M4-0.7*6) -----	2
34	220A0001632	護目鏡組 Safety Plate Asm. -----	1
35	66451	貼紙 Paster -----	1
36	66831	工具袋 Bag -----	1
37	-----	零件冊 Parts List -----	-
38	-----	使用說明書 Instruction Manual -----	-
39	-----	-----	-
40	66840	穿線鋼絲 Threading Bar -----	1
41	2100001521	過濾器 Oil Filter -----	1
42	66722	漏斗 Oil Funnel -----	1
43	66848	防塵罩 Mechine Cover -----	1
44	66721	油壺 Oiler -----	1
45	66720	矽油 Silicon Oil -----	1
46	4UTB020306	束線 Plastic Binding Wire -----	2
47	8TE03440806A	螺絲 Screw -----	2
48	8MB04281007K	螺絲 Screw (CT1237 M4-0.7*10)-----	1
49	90DW040	碟形墊圈 Disk Washer -----	1

* CTD9000 / CXD2000 控制箱種類依馬達及電、氣切線裝置購買

** 需整組購買 Must be sold in complete set

△ CXM2000 專用 (控制箱種類依馬達及電、氣切線裝置購買)

機型	項次	37	38
		零件冊	使用說明書
CTD9000		6CT6300-1M-06-01	6CT62M0-4-07-10
CXD2000 / CXD2000 / CXM2000		6CXD630A-1-12-06	6CXD62MA-01-12-06

項次	機型	CXM2000	CTD9000 / CXD2000
		標配品	選購品
8			



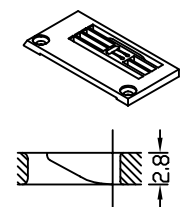
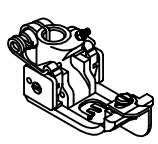
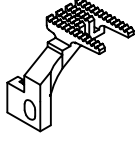
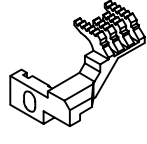
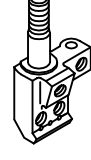
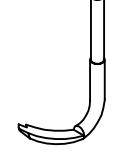
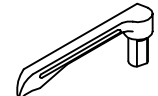
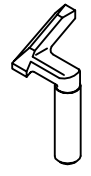
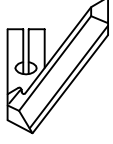
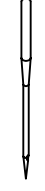

CTD9000-0-0 □□□W
 CTD9000-0- □□□W

CTD9000 GAUGE PARTS LIST

Main Parts 更換零件											針	針距
											數	m.m
3	5.6	5220TP00568	5220PF00564	5220FD00563	5220DF00560	5227NC00560	5220SL00560	5220LL00560	5220NG00563	5220NG00562	UY128GAS # 11	
				5220DG0016								
3	6.4	5220TP00646	5220PF00644	5220FD00643	5220DF00640	5227NC00640						
				5220DG0017								

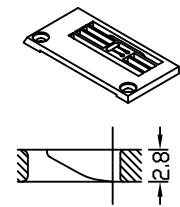
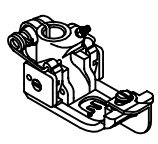
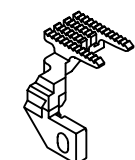
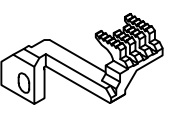
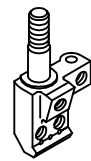
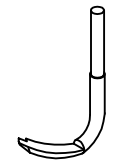

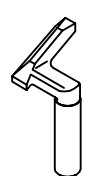
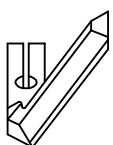
-37-

CTD9000-0-0 □□□W/CS002
 CTD9000-0- □□□W/CS002

Main Parts 更換零件											針	針距
											數	m.m
3	5.6	5220TP00568	5220PF00564	5227FD00560	5227DF00561	5227NC00560	5220SL00560	5220LL00560	5220NG00563	5220NG00562	UY128GAS # 11	
				5227DG0005								
3	6.4	5220TP00646	5220PF00644	5227FD00640	5227DF00640	5227NC00640						
				5227DG0008								



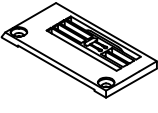
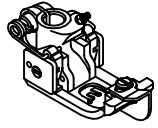
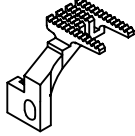
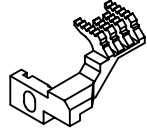
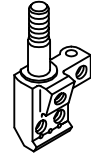
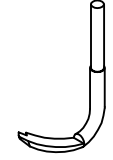
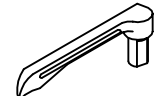
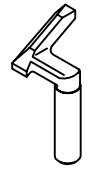
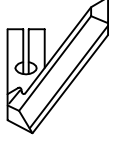

CTD9000-0-0 □□□L
CTD9000-0- □□□L

CTD9000 GAUGE PARTS LIST

Main Parts 更換零件	針 針	數 距	Needle m.m	 Throat plate 針板	 Presser foot asm 壓腳	 Main feed dog 主送布齒	 Diff feed dog 副送布齒	 Needle clamp 針留	 Upper looper 上結線鉤	 Lower looper 下結線鉤	 Needle guide 前導針	 Needle guide 後導針	 Needle 針
2	4.0	5222TP00402	5220PF00404	5220FD00563 5220DG0016	5220DF00560 5220DG0016	5220NC00400	5220SL00560	5220LL00560	5220NG00563	5220NG00562	UY128GAS # 11		
2	4.8	5222TP00481	5220PF00484	5220FD00563 5220DG0016	5220DF00560 5220DG0016	5220NC00480							
3	4.8	5222TP00481	5220PF00485	5220FD00563 5220DG0016	5220DF00560 5220DG0016	5220NC00485							
3	5.6	5222TP00560	5220PF00564	5220FD00563 5220DG0016	5220DF00560 5220DG0016	5227NC00560							
3	6.4	5222TP00640	5220PF00644	5220FD00643 5220DG0017	5220DF00640 5220DG0017	5227NC00640							

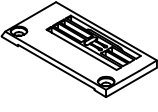
-38-

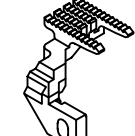
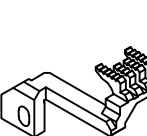
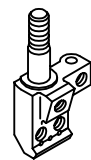
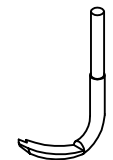
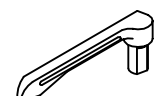
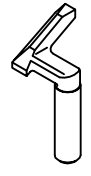
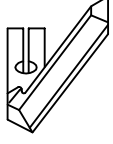
CTD9000-0-0 □□□L/CS002
CTD9000-0- □□□L/CS002

Main Parts 更換零件	針 針	數 距	Needle m.m	 Throat plate 針板	 Presser foot asm 壓腳	 Main feed dog 主送布齒	 Diff feed dog 副送布齒	 Needle clamp 針留	 Upper looper 上結線鉤	 Lower looper 下結線鉤	 Needle guide 前導針	 Needle guide 後導針	 Needle 針
2	4.0	5222TP00402	5220PF00404	5227FD00560 5227DG0005	5227DF00561 5227DG0005	5220NC00400	5220SL00560	5220LL00560	5220NG00563	5220NG00562	UY128GAS # 11		
2	4.8	5222TP00481	5220PF00484	5227FD00560 5227DG0005	5227DF00561 5227DG0005	5220NC00480							
3	4.8	5222TP00481	5220PF00485	5227FD00560 5227DG0005	5227DF00561 5227DG0005	5220NC00485							
3	5.6	5222TP00560	5220PF00564	5227FD00560 5227DG0005	5227DF00561 5227DG0005	5227NC00560							
3	6.4	5222TP00640	5220PF00644	5227FD00640 5227DG0008	5227DF00640 5227DG0008	5227NC00640							

CTD9000-0-0 □□□S
CTD9000-0- □□□S

CTD9000 GAUGE PARTS LIST





針 數 Needle	針 距 m.m	Main Parts 更換 零件		Presser foot asm 壓腳	Main feed dog 主送布齒	Diff feed dog 副送布齒	Aux feed dog 輔助送布齒	Needle clamp 針留	Upper looper 上結線鉤	Lower looper 下結線鉤	Needle guide 前導針	Needle guide 後導針	Needle 針
		Throat plate 針板	Stitch plate Tongue 針板舌										
2	4.0	5222TP0056B	5222TPL140A	5220PF00404	5222FD00560	5222DF00560	5222AF00560	5220NC00400	5220SL00560	5220LL00560	5220NG00563	5220NG00562	UY128GAS # 11
		5222TP00403											
3	4.8	5222TP0056B	5222TPL148A	5220PF00485	5222FD00560	5222DF00560	5222AF00560	5220NC00485	5220SL00560	5220LL00560	5220NG00563	5220NG00562	UY128GAS # 11
		5222TP00483											
3	5.6	5222TP0056B	5222TPL156A	5220PF00564	5222FD00560	5222DF00560	5222AF00560	5227NC00560	5220SL00560	5220LL00560	5220NG00563	5220NG00562	UY128GAS # 11
		5222TP00563											
3	6.4	5222TP0056B	5222TPL164A	5220PF00644	5222FD00560	5222DF00560	5222AF00560	5227NC00640	5220SL00560	5220LL00560	5220NG00563	5220NG00562	UY128GAS # 11
		5222TP00643											

CTD9000-0-0 □□□S1
CTD9000-0- □□□S1

針 數 Needle	針 距 m.m	Main Parts 更換 零件		Presser foot asm 壓腳	Main feed dog 主送布齒	Diff feed dog 副送布齒	Aux feed dog 輔助送布齒	Needle clamp 針留	Upper looper 上結線鉤	Lower looper 下結線鉤	Needle guide 前導針	Needle guide 後導針	Needle 針
		Throat plate 針板	Stitch plate Tongue 針板舌										
2	4.0	5227TP0056B	5222TPL140C	5220PF00404	5222FD00560	5222DF00560	5222AF00560	5220NC00400	5220SL00560	5220LL00560	5220NG00563	5220NG00562	UY128GAS # 11
		5227TP00403											
3	4.8	5227TP0056B	5222TPL148C	5220PF00485	5222FD00560	5222DF00560	5222AF00560	5220NC00485	5220SL00560	5220LL00560	5220NG00563	5220NG00562	UY128GAS # 11
		5227TP00483											
3	5.6	5227TP0056B	5222TPL156C	5220PF00564	5222FD00560	5222DF00560	5222AF00560	5227NC00560	5220SL00560	5220LL00560	5220NG00563	5220NG00562	UY128GAS # 11
		5227TP00563											
3	6.4	5227TP0056B	5222TPL164C	5220PF00644	5222FD00560	5222DF00560	5222AF00560	5227NC00640	5220SL00560	5220LL00560	5220NG00563	5220NG00562	UY128GAS # 11
		5227TP00643											

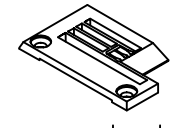
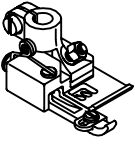
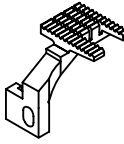
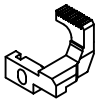
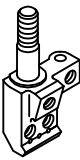
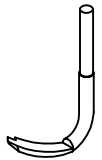

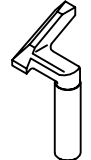
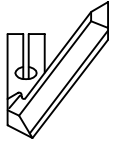
CTD9000 GAUGE PARTS LIST

CTD9003-0-□□□M

Main Parts 更換零件											Needle 針	針
												數
2	3.2	5222TP03321	5222PF03321	5222FD03560	5222DF03560	5221NC15320	5220SL00560	5220LL00560	5220NG00563	5220NG00562	UY128GAS # 11	
				5222DG0005								
2	4.0	5222TP03401	5222PF03401	5222FD03560	5222DF03560	5220NC00400						
				5222DG0005								
3	4.8	5222TP03482	5222PF03482	5222FD03560	5222DF03560	5220NC00485						
				5222DG0005								
3	5.6	5222TP03561	5222PF03561	5222FD03560	5222DF03560	5227NC00560						
				5222DG0005								
3	6.4	5222TP03641	5222PF03641	5222FD03560	5222DF03560	5227NC00640						
				5222DG0005								

-40-

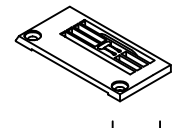
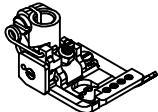
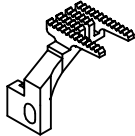
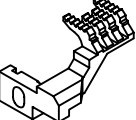
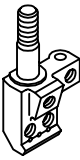
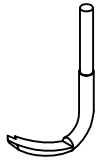
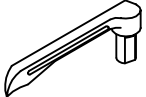
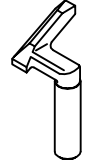
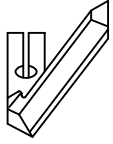
CTD9011-0- □□□M

Main Parts 更換零件											Needle 針	針
												數
2	4.0	5222TP00401	5222PF11400	5222FD00563	5222DF00560	5220NC00400	5220SL00560	5220LL00560	5220NG00563	5220NG00562	UY128GAS # 11	
				5220DG0016								
2	4.8	5220TP00484	5222PF11480	5222FD00563	5222DF00560	5220NC00480						
				5220DG0016								
3	5.6	5220TP00564	5222PF11560	5222FD00563	5222DF00560	5227NC00560						
				5220DG0016								
3	6.4	5220TP00642	5222PF11640	5222FD00643	5222DF00640	5227NC00640						
				5220DG0017								

CTD9000 GAUGE PARTS LIST

CTD9011-0- □□□M/CS002

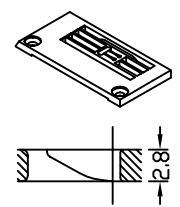
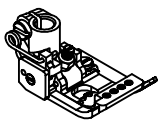

針 數 Needle	針 距 m.m	Main Parts 更換 零件		Main feed dog 主送布齒	Diff feed dog 副送布齒	Needle clamp 針留	Upper looper 上結線鉤	Lower looper 下結線鉤	Needle guide 前導針	Needle guide 後導針	Needle 針
											
2	4.0	5222TP00401	5222PF11400	5227FD00560	5227DF00561	5220NC00400	5220SL00560	5220LL00560	5220NG00563	5220NG00562	UY128GAS # 11
				5227DG0005		5220NC00480					
2	4.8	5220TP00484	5222PF11480	5227FD00560	5227DF00561	5220NC00480					
				5227DG0005		5227NC00560					
3	5.6	5220TP00564	5222PF11560	5227FD00560	5227DF00561	5227NC00560					
				5227DG0005							
3	6.4	5220TP00642	5222PF11640	5227FD00640	5227DF00640	5227NC00640					
				5227DG0008							

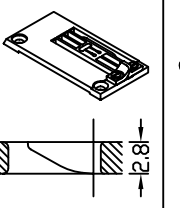
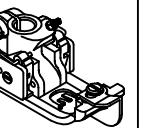
CTD9013-0- □□□M

針 數 Needle	針 距 m.m	Main Parts 更換 零件		Main feed dog 主送布齒	Diff feed dog 副送布齒	Aux feed dog 輔助送布齒	Needle clamp 針留	Upper looper 上結線鉤	Lower looper 下結線鉤	Needle guide 前導針	Needle guide 後導針	Needle 針
												
2	4.0	5222TP13403	5220PF00404	5220FD00563	5220DF13563	5220AF13560	5220NC00400	5220SL00560	5220LL00560	5220NG00563	5220NG00562	UY128GAS # 11
					5222DG0001		5220NC00480					
2	4.8	5222TP13483	5220PF00484	5220FD00563	5220DF13563	5220AF13560	5220NC00480					
					5222DG0001		5220NC00485					
					5222DG0001		5227NC00560					
3	4.8	5222TP13483	5220PF00485	5220FD00563	5220DF13563	5220AF13560	5220NC00485					
					5222DG0001							
3	5.6	5222TP13563	5220PF00564	5220FD00563	5220DF13563	5220AF13560	5227NC00560					
					5222DG0001							
3	6.4	5222TP13643	5220PF00644	5220FD00643	5220DF13643	5220AF13640	5227NC00640					
					5222DG0002							

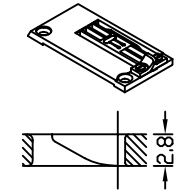
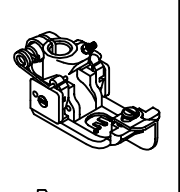
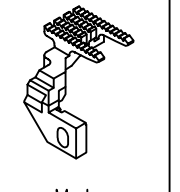
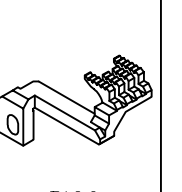
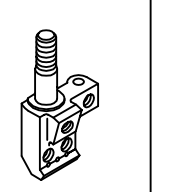
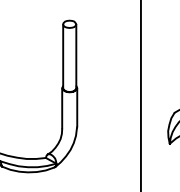
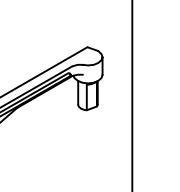
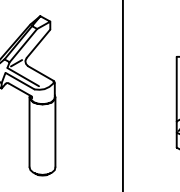
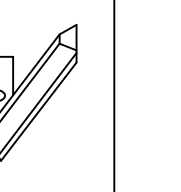

CTD9000 GAUGE PARTS LIST

CTD9013-0- □□□M/CS002

Main Parts 更換零件											針	數	距
											針	Needle	m.m
	Throat plate 針板	Presser foot asm 壓腳	Main feed dog 主送布齒	Diff feed dog 副送布齒	Needle clamp 針留	Upper looper 上結線鉤	Lower looper 下結線鉤	Needle guide 前導針	Needle guide 後導針	Needle 針			
2	4.0	5222TP13403	5220PF00404	5227FD00560	5227DF00561	5220NC00400	5220SL00560	5220LL00560	5220NG00563	5220NG00562	UY128GAS # 11		
				5227DG0005									
2	4.8	5222TP13483	5220PF00484	5227FD00560	5227DF00561	5220NC00480							
				5227DG0005									
3	5.6	5222TP13563	5220PF00564	5227FD00560	5227DF00561	5227NC00560							
				5227DG0005									
3	6.4	5222TP13643	5220PF00644	5227FD00640	5227DF00640	5227NC00640							
				5227DG0008									



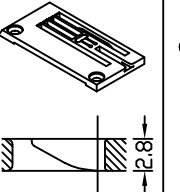
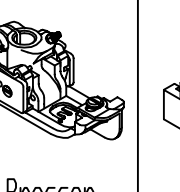
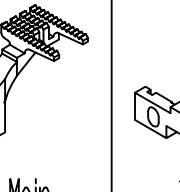
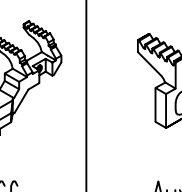
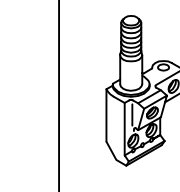
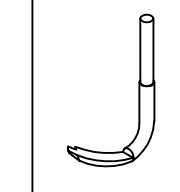
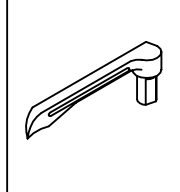
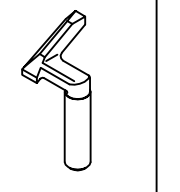
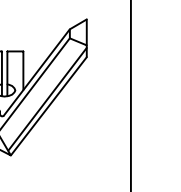

-42-

CTD9013-1- □□□M



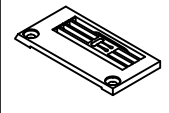
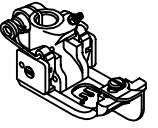
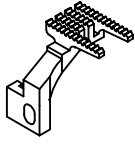
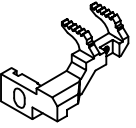
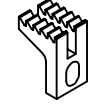
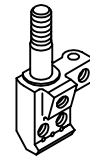
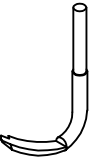
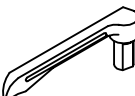

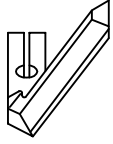

Main Parts 更換零件											針	數	距
											針	Needle	m.m
	Throat plate 針板	Presser foot asm 壓腳	Main feed dog 主送布齒	Diff feed dog 副送布齒	Aux feed dog 輔助送布齒	Needle clamp 針留	Upper looper 上結線鉤	Lower looper 下結線鉤	Needle guide 前導針	Needle guide 後導針	Needle 針		
2	4.0	5222TP13404	5220PF00404	5220FD00563	5220DF13563	5220AF13561	5220NC00400	5220SL00560	5220LL00560	5220NG00563	5220NG00562		
				5222DG0003									
2	4.8	5222TP13484	5220PF00484	5220FD00563	5220DF13563	5220AF13561	5220NC00480						
				5222DG0003									
3	4.8	5222TP13484	5220PF00485	5220FD00563	5220DF13563	5220AF13561	5220NC00485						
				5222DG0003									
3	5.6	5222TP13564	5220PF00564	5220FD00563	5220DF13563	5220AF13561	5227NC00560						
				5222DG0003									
3	6.4	5222TP13644	5220PF00644	5220FD00643	5220DF13643	5220AF13561	5227NC00640						
				5222DG0004									

CTD9000 GAUGE PARTS LIST

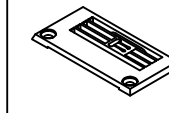
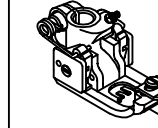
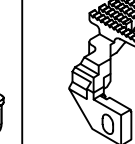
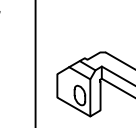
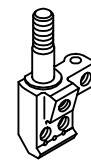
CTD9013-2- □□□M

Main Parts 更換零件												針距 Needle m.m	針數		Main Parts		
													針	數	更換零件	Main Parts	
	Throat plate 針板	Presser foot asm 壓腳	Main feed dog 主送布齒	Diff feed dog 副送布齒	Aux feed dog 輔助送布齒	Needle clamp 針留	Upper looper 上結線鉤	Lower looper 下結線鉤	Needle guide 前導針	Needle guide 後導針	Needle 針						
2	4.0	5222TP13402	5220PF00404	5220FD00563	5220DF13563	5220AF13560	5220NC00400										
2	4.8	5222TP13482	5220PF00484	5220FD00563	5220DF13563	5220AF13560	5220NC00480										
3	4.8	5222TP13482	5220PF00485	5220FD00563	5220DF13563	5220AF13560	5220NC00485	5220SL00560	5220LL00560	5220NG00563	5220NG00562						UY128GAS # 11
3	5.6	5222TP13562	5220PF00564	5220FD00563	5220DF13563	5220AF13560	5227NC00560										
3	6.4	5222TP13642	5220PF00644	5220FD00643	5220DF13643	5220AF13640	5227NC00640										

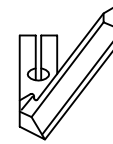
CTD9013-2- □□□M/CS002

Main Parts 更換零件											針距 Needle m.m	針數		Main Parts			
												針	數	更換零件	Main Parts		
	Throat plate 針板	Presser foot asm 壓腳	Main feed dog 主送布齒	Diff feed dog 副送布齒	Needle clamp 針留	Upper looper 上結線鉤	Lower looper 下結線鉤	Needle guide 前導針	Needle guide 後導針	Needle 針							
2	4.0	5222TP13402	5220PF00404	5227FD00560	5227DF00561	5220NC00400											
2	4.8	5222TP13482	5220PF00484	5227FD00560	5227DF00561	5220NC00480											
3	5.6	5222TP13562	5220PF00564	5227FD00560	5227DF00561	5227NC00560	5220SL00560	5220LL00560	5220NG00563	5220NG00562							UY128GAS # 11
3	6.4	5222TP13642	5220PF00644	5227FD00640	5227DF00640	5227NC00640											

CTD9000 GAUGE PARTS LIST

CTD9042-0- □□□M CTD9042-3- □□□M
 CTD9042-1- □□□M CTD9042-5- □□□M
 CTD9042-2- □□□M

Main Parts 更換零件 針 針 數 Needle	針 距 m.m	Throat plate 針板		Presser foot asm 壓?		Main feed dog 主送布齒		Diff feed dog 副送布齒		Needle clamp 針留		Upper looper 上結線鉤		Lower looper 下結線鉤		Needle guide 前導針		Needle guide 後導針		Needle 針	
		5.6	6.4	5220TP42562	5220PF42561	5220FD42562	5220DF42562	5220DG0011	5220DF42562	5227NC00560	5220SL00560	5220LL00560	5220NG00563	5220NG00562	UY128GAS # 11						
3	5.6	5220TP42562	5220PF42561	5220FD42562	5220DF42562	5220DG0011	5220DF42562	5227NC00560	5220SL00560	5220LL00560	5220NG00563	5220NG00562									
3	6.4	5220TP42642	5220PF42641	5220FD42562	5220DF42562	5220DG0011	5220DF42562	5227NC00640	5220SL00560	5220LL00560	5220NG00563	5220NG00562									

-4-

CTD9060-0-4 □□M

Main Parts 更換零件 針 針 數 Needle	針 距 m.m	Throat plate 針板		Presser foot asm 壓?		Main feed dog 主送布齒		Diff feed dog 副送布齒		Needle clamp 針留		Upper looper 上結線鉤		Lower looper 下結線鉤		Needle guide 前導針		Needle guide 後導針		Needle 針	
		5.2	5.6	5227TP60520	5221PF60521	5220FD00643	5220DF00640	5220DG0017	5220DF00640	5228NC60521	5220SL00560	5220LL60560	5220NG60560	5220NG00562	MY1014B # 11						
4	5.2	5227TP60520	5221PF60521	5220FD00643	5220DF00640	5220DG0017	5220DF00640	5228NC60521	5220SL00560	5220LL60560	5220NG60560	5220NG00562									
4	5.6	5227TP60560	5221PF60561	5220FD00643	5220DF00640	5220DG0017	5220DF00640	5228NC60561													
4	6.0	5227TP60600	5221PF60601	5220FD00643	5220DF00640	5220DG0017	5220DF00640	5228NC60601													
4	6.4	5227TP60640	5221PF60641	5220FD00643	5220DF00640	5220DG0017	5220DF00640	5228NC60641													

*OPTION-MAKE TO ORDER

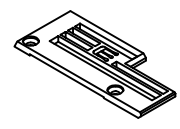
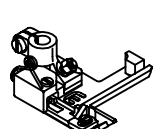
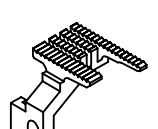
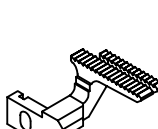
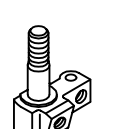
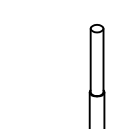
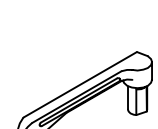
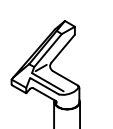
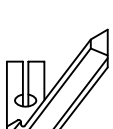
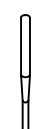

CTD9000 GAUGE PARTS LIST

CTD9085-0- □□□M

Main Parts 更換零件											針	針距
											數	Needle
	Throat plate 針板	Presser foot asm 壓腳	Main feed dog 主送布齒	Diff feed dog 副送布齒	Needle clamp 針留	Upper looper 上結線鉤	Lower looper 下結線鉤	Needle guide 前導針	Needle guide 後導針	Needle 針		
2	4.0	5220TP85400	5222PF85400	5220FD85561 5220DG0010	5220DF85561	5220NC00400	5220SL00560	5220LL00560	5220NG00563	5220NG00562	UY128GAS # 11	
2	4.8	5220TP85480	5222PF85480	5220FD85561 5220DG0010	5220DF85561	5220NC00480						
3	5.6	5220TP85560	5222PF85560	5220FD85561 5220DG0010	5220DF85561	5227NC00560						
3	6.4	5220TP85641	5222PF85640	5220FD85561 5220DG0010	5220DF85561	5227NC00640						

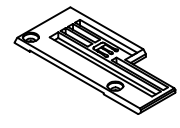
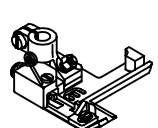
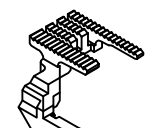
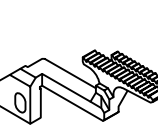
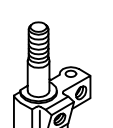
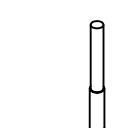

CTD9085-0- □□□M/CS001

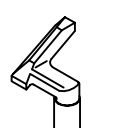
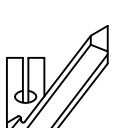
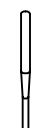
CTD9085-0- □□□M/CS01P

Main Parts 更換零件											針	針距
											數	Needle
	Throat plate 針板	Presser foot asm 壓腳	Main feed dog 主送布齒	Diff feed dog 副送布齒	Needle clamp 針留	Upper looper 上結線鉤	Lower looper 下結線鉤	Needle guide 前導針	Needle guide 後導針	Needle 針		
2	4.0	5220TP85400	5222PF85400	5227FD85560 5227DG0006	5227DF85561	5220NC00400	5220SL00560	5220LL00560	5220NG00563	5220NG00562	UY128GAS # 11	
2	4.8	5220TP85480	5222PF85480	5227FD85560 5227DG0006	5227DF85561	5220NC00480						
3	5.6	5220TP85560	5222PF85560	5227FD85560 5227DG0006	5227DF85561	5227NC00560						
3	6.4	5220TP85641	5222PF85640	5227FD85560 5227DG0006	5227DF85561	5227NC00640						

CTD9000 GAUGE PARTS LIST

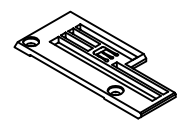
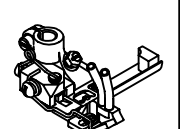
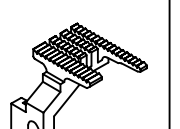
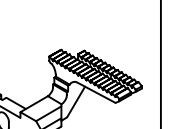
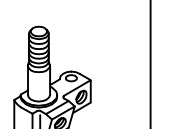
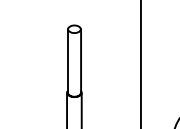
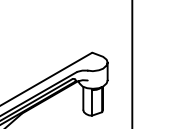
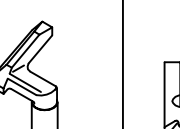
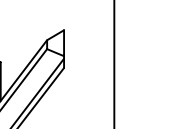

CTD9085-0- □□□M/AF01 □

Main Parts 更換零件											針	針
											數	距
2	4.0	5220TP85400	5222AF85400	5220FD85561 5220DG0010	5220DF85561	5220NC00400	5220SL00560	5220LL00560	5220NG00563	5220NG00562	UY128GAS # 11	
2	4.8	5220TP85480	5222AF85480	5220FD85561 5220DG0010	5220DF85561	5220NC00480						
3	5.6	5220TP85560	5222AF85560	5220FD85561 5220DG0010	5220DF85561	5227NC00560						
3	6.4	5220TP85641	5222AF85640	5220FD85561 5220DG0010	5220DF85561	5227NC00640						

-46-

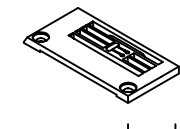
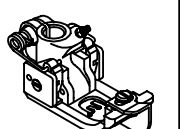
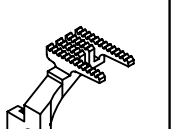
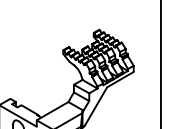
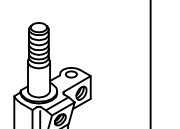
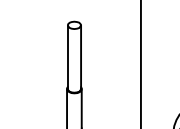
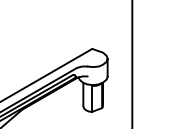
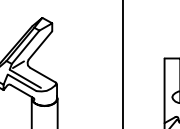
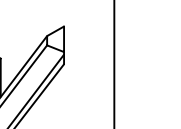

CTD9200-0-0 □□□H

CTD9200-0- □□□H

Main Parts 更換零件											針	針
											數	距
3	5.6	5220TP00567	5220PF00563	5220FD00565 5220DG0024	5220DF00561	5227NC00560	5220SL00560	5220LL00560	5220NG00563	5220NG00562	UY128GAS # 14	
3	6.4	5220TP00645	5220PF00643	5220FD00565 5220DG0024	5220DF00561	5227NC00640						

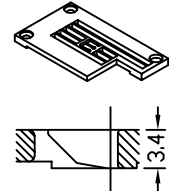
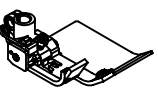
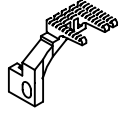
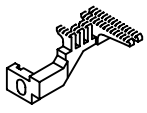
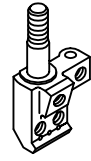
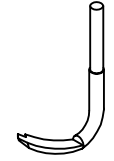
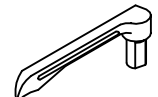
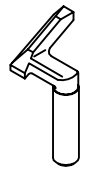
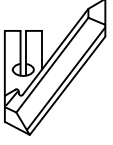

CTD9311-0-0 □□□M
CTD9311-0- □□□M

CTD9000 GAUGE PARTS LIST

Main Parts 更換零件											針	針距
											數	Needle
	Throat plate 針板	Presser foot asm 壓腳	Main feed dog 主送布齒	Diff feed dog 副送布齒	Needle clamp 針留	Upper looper 上結線鉤	Lower looper 下結線鉤	Needle guide 前導針	Needle guide 後導針	Needle 針		
2	4.0	5227TPL1400	5222PFL1400	5220F DL1561	5220DFL1561	5220NC00400	5220SL00560	5220LL00560	5220NG00563	5220NG00562	UY128GAS # 11	
2	4.8	5227TPL1480	5222PFL1480									5220NC00480
3	4.8	5227TPL1481	5222PFL1481	組件 5220DG0012	5220NC00485							
3	5.6	5227TPL1560	5222PFL1560		5227NC00560							
3	6.4	5227TPL1640	5222PFL1640		5227NC00640							



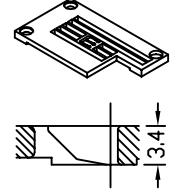
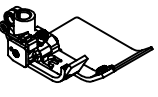
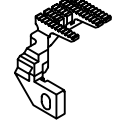
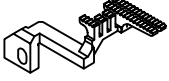
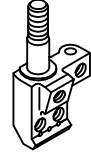
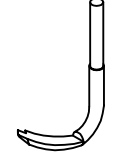
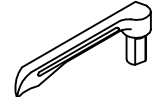
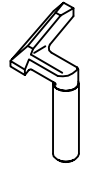
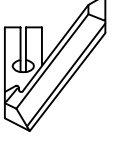

-47-

CTD9311-0-0 □□□M/CS003
CTD9311-0- □□□M/CS003

Main Parts 更換零件											針	針距
											數	Needle
	Throat plate 針板	Presser foot asm 壓腳	Main feed dog 主送布齒	Diff feed dog 副送布齒	Needle clamp 針留	Upper looper 上結線鉤	Lower looper 下結線鉤	Needle guide 前導針	Needle guide 後導針	Needle 針		
2	4.0	5227TPL1400	5222PFL1400	5227F DL1560	5227DFL1561	5220NC00400	5220SL00560	5220LL00560	5220NG00563	5220NG00562	UY128GAS # 11	
2	4.8	5227TPL1480	5222PFL1480									5220NC00480
3	4.8	5227TPL1481	5222PFL1481	組件 5227DG0007	5220NC00485							
3	5.6	5227TPL1560	5222PFL1560		5227NC00560							
3	6.4	5227TPL1640	5222PFL1640		5227NC00640							

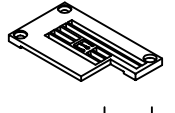

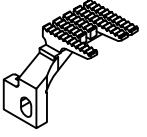
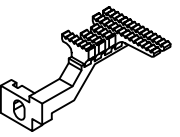
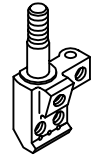
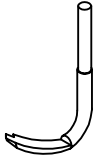
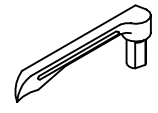
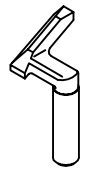
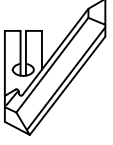

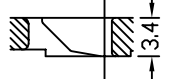
CTD9311-0-0 □□□L
 CTD9311-0- □□□L

CTD9000 GAUGE PARTS LIST

Main Parts 更換零件											Needle 針	針	針距	
												數	距 m.m	
														
	Throat plate 針板	Presser foot asm 壓腳	Main feed dog 主送布齒	Diff feed dog 副送布齒	Needle clamp 針留	Upper looper 上結線鉤	Lower looper 下結線鉤	Needle guide 前導針	Needle guide 後導針	Needle 針				
3	5.6	5227TPL1560	5222PFL1560	5227FDL1562 / 5227DFL1562 組件 5227DG0009	5227NC00560	5220SL00560	5220LL00560	5220NG00563	5220NG00562	UY128GAS # 11				

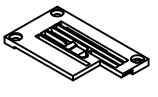
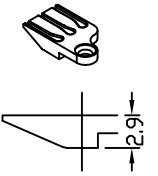
-48-

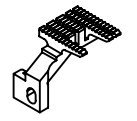
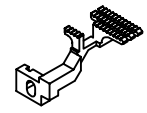
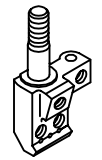
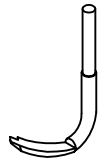
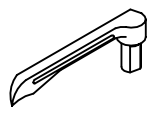
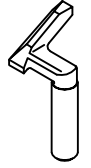
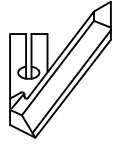
CTD9311-0-0 □□□S
 CTD9311-0- □□□S

Main Parts 更換零件												Needle 針	針	針距
													數	距 m.m
	Throat plate 針板	Stitch plate Tongue 針板舌	Presser foot asm 壓腳	Main feed dog 主送布齒	Diff feed dog 副送布齒	Needle clamp 針留	Upper looper 上結線鉤	Lower looper 下結線鉤	Needle guide 前導針	Needle guide 後導針	Needle 針			
2	4.0	5222TPL156B 5222TPL140A 5222TPL1402	5222PFL1400	5222FDL1560 / 5222DFL1560 組件 5222DG0009		5220NC00400	5220SL00560	5220LL00560	5220NG00563	5220NG00562	UY128GAS # 11			
2	4.8	5222TPL156B 5222TPL148A 5222TPL1482	5222PFL1480		5220NC00480									
3	4.8	5222TPL156B 5222TPL148A 5222TPL1482	5222PFL1481		5220NC00485									
3	5.6	5222TPL156B 5222TPL156A 5222TPL1562	5222PFL1560		5227NC00560									
3	6.4	5222TPL156B 5222TPL164A 5222TPL1642	5222PFL1640		5227NC00640									

CTD9311-0-0 □□□S1
 CTD9311-0- □□□S1

CTD9000 GAUGE PARTS LIST

Main Parts 更換零件 機針 型距 Models m.m	Throat plate 針板		Stitch plate Tongue 針板舌	Presser foot asm 壓腳	Main feed dog 主送布齒	Diff feed dog 副送布齒	Needle clamp 針留	Upper looper 上結線鉤	Lower looper 下結線鉤	Needle guide 前導針	Needle guide 後導針	Needle 針
	5227TPL156B 5222TPL140C 5227TPL1402		5227TPL156B 5222TPL148C 5227TPL1482	5222PFL1400	5222FDL1560 / 5222DFL1560 組件 5222DG0009	5222DFL1560 / 5222DFL1560 組件 5222DG0009	5220NC00400	5220SL00560	5220LL00560	5220NG00563	5220NG00562	UY128GAS # 11
2	4.0	5227TPL156B 5222TPL140C 5227TPL1402		5222PFL1400			5220NC00400					
2	4.8	5227TPL156B 5222TPL148C 5227TPL1482		5222PFL1480			5220NC00480					
3	4.8	5227TPL156B 5222TPL148C 5227TPL1482		5222PFL1481			5220NC00485					
3	5.6	5227TPL156B 5222TPL156C 5227TPL1562		5222PFL1560			5227NC00560					
3	6.4	5227TPL156B 5222TPL164C 5227TPL1642		5222PFL1640			5227NC00640					





-49-

CTD9311-0-0 □□□S2
 CTD9311-0- □□□S2

Main Parts 更換零件 機針 型距 Models m.m	Throat plate 針板		Presser foot asm 壓腳	Main feed dog 主送布齒	Diff feed dog 副送布齒	Needle clamp 針留	Upper looper 上結線鉤	Lower looper 下結線鉤	Needle guide 前導針	Needle guide 後導針	Needle 針
	5227TPL1561 5222PFL1560 5227TPL1641		5222PFL1560	5222FDL1561 / 5222DFL1561 組件 5222DG0011	5222DFL1561 / 5222DFL1561 組件 5222DG0011	5227NC00560	5220SL00560	5220LL00560	5220NG00563	5220NG00562	UY128GAS # 11
3	5.6	5227TPL1561 5222PFL1560 5227TPL1641				5222PFL1560					
3	6.4	5227TPL1561 5222PFL1560 5227TPL1641		5222PFL1640	5227NC00640						

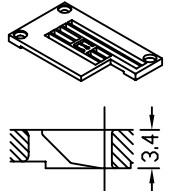
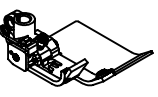
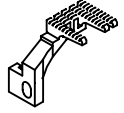
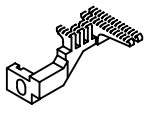
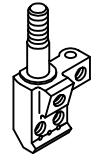
CTD9311-0-0□□□H
 CTD9311-0-□□□H

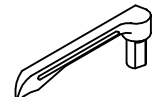
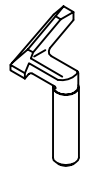
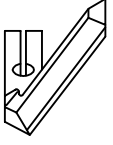
CTD9000 GAUGE PARTS LIST

Main Parts 更換零件											針
											針距 Needle m.m
	Throat plate 針板	Presser foot asm 壓腳	Main feed dog 主送布齒	Diff feed dog 副送布齒	Needle clamp 針留	Upper looper 上結線鉤	Lower looper 下結線鉤	Needle guide 前導針	Needle guide 後導針	Needle 針	
2	4.0	5227TPL1400	5222PFL1400	5227FDL1561	5220DFL1561	5220SL00560	5220LL00560	5220NG00563	5220NG00562	UY128GAS # 11	5220NC00400
2	4.8	5227TPL1480	5222PFL1480								5220NC00480
3	4.8	5227TPL1481	5222PFL1481	5220NC00480							
3	5.6	5227TPL1560	5222PFL1560	組件 5227DG0004	5227NC00560						
3	6.4	5227TPL1640	5222PFL1640		5227NC00640						